



**WE ARE A
PROUD
MEMBER OF**

HARDI





MA-12700A
MEGOHMMETER
AUTO-RANGING
INSULATION
TESTER



NEW!!!
MA-1028
DIGITAL MULTI-METER
WITH TEMPERATURE
TRUE RMS
CAT III 600V



MA-12827
COMPACT
DIGITAL
MULTI-METER



MECHANICAL DOORS
TO PREVENT WRONG
HOOK-UP

MA-12817B
DIGITAL
MULTI-METER
WITH TEMP.

MA-12818
DIGITAL
MULTI-METER
WITH TEMP.



FUNCTION	MA-1028	MA-12700A	MA-12817B	MA-12818	MA-12827
DCV	60mV, 600mV, 6V, 60V, 600V, 1000V	0.1mV	200mV, 2V, 20V, 200V, 1000V	200mV, 2V, 20V, 200V, 1000V	1000V
ACV (50/60Hz)	60mV, 600mV, 6V, 60V, 600V, 750V	100V, 250V, 500V, 1000V	200mV, 2V, 20V, 200V, 700V	2V, 20V, 200V, 700V	1000V
DCA	60mA, 600mA, 6A, 10A		2mA, 20mA, 200mA, 10A	2mA, 200mA, 10A	10A
ACA	60mA, 600mA, 6A, 10A		2mA, 20mA, 200mA, 10A	20mA, 200mA, 10A	10A
RESISTANCE	600Ω, 6kΩ, 60kΩ, 600kΩ, 6MΩ	1MΩ - 20GΩ	200Ω, 2kΩ, 20kΩ, 200kΩ, 2MΩ, 20MΩ, 200MΩ	200Ω, 2kΩ, 20kΩ, 200kΩ, 2MΩ, 20MΩ, 200MΩ	40MΩ
TEMPERATURE	-4F TO 1832F -20C TO 1000C		-40F TO 1832F (-40C TO 1000C)	-20F TO 1832F (-29C TO 1000C)	-58F TO 1832F (-50C TO 1000C)
CAPACITANCE	9.999nF, 99.99nF, 999.9nF, 9.999μF, 99.99μF, 999.9μF, 9.999mF		2nF, 20nF, 200nF, 2μF, 200μF	20nF, 200nF, 20μF, 2000μF	200μF
FREQUENCY	99.99Hz, 999.9Hz, 9.999kHz, 99.99kHz, 999.9kHz, 9.999MHz			2000kHz	10MHz
DUTY CYCLE	1% TO 9%				99.9%
DIODE TEST	*				
CONTINUITY	*	*			
TEST LEADS	MA-DMTL1	YES	MA-DMTL1	MA-DMTL1	MA-DMTL1
PROBE	MA-DMTP		MA-DMTK	MA-DMTP	MA-DMTKA
BATTERY	(2) AAA	(6) AA	(1) 9V	(1) 9V	(1) 9V
CASE	*	*	*	*	*

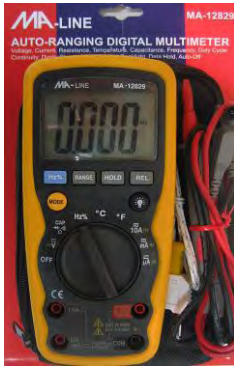

MA-12829
AUTO-RANGING
DIGITAL
MULTI-METER



MA-12837
AC/DC DIGITAL
MULTI-METER WITH
AUTO SELECTION



MA-33C
PALM SIZE
DIGITAL
MULTI-METER



MA-MY69
AUTO-RANGING
DIGITAL
MULTI - METER

FUNCTION	MA-12829	MA-12837	MA-33C	MA-MY69
DCV	1000V	600V	200mV, 2000mV, 20V, 200V, 500V	400mV - 1000V
ACV (50/60Hz)	1000V	600V	200V, 500V	400mV - 750V
DCA	10A		2000µA, 20mA, 200mA, 10A	400uA - 10A
ACA	10A			400uA - 10A
RESISTANCE	40MΩ	60MΩ	200Ω, 2000Ω, 20KΩ, 200KΩ, 20MΩ	400Ω - 40MΩ
TEMPERATURE	-58F TO 1832F (-50C TO 1000C)		-40F TO 1832F (-40C TO 1000C)	-4F - 1400F (-20C - 750C)
CAPACITANCE	100uF	30mF		4nF - 200uF
FREQUENCY	10MHz	100kHz		100Hz - 10MHz
DUTY CYCLE	99.9%	99.9%		.1% - 99.9%
DIODE TEST		*		*
TRANSISTOR TEST				*
CONTINUITY		*		*
TEST LEADS	MA-DMTL1	MA-DMTL1	MA-DMTL1	MA-DMTL1
PROBE	MA-DMTK1		MA-DMTP	MA-DMTK
BATTERY	(1) 9V	(1) 9V	(1) 9V	(1) 9V
CASE	*	*	*	*



MA-DM1
DIGITAL MULTI-METER
 INCLUDES :
 MA-DMTL, CASE,
 MANUAL & BATTERIES

MA-DMT3
DIGITAL MULTI-METER
WITH TEMPERATURE
 INCLUDES:
 MA-DMTL, MA-DMTP, CASE, MANUAL
 & BATTERIES

FUNCTION	MA-DM1	MA-DMT3
DCV	200mV, 2V, 20V, 200V, 1000V	200mV, 2V, 20V, 200V, 1000V
ACV (50/60Hz)	200V (750V)	200V (750V)
DCA	200µA, 2000µA, 20mA, 200mA, 10A	200µA, 2000µA, 20mA, 200mA, 10A
OHM	200Ω, 2000Ω, 20KΩ, 200KΩ, 2000KΩ	200Ω, 2000Ω, 20KΩ, 200KΩ, 2000KΩ
TEMPERATURE	NO	-58F TO 2498F (-50C TO 1370C)
DIODE TEST	Test Current 1.6mA: Voltage 2.8V	Test Current 1.6mA: Voltage 2.8V
TRANSISTOR TEST	0-1000 hFE of PNP or NPN transistors	0-1000 hFE of PNP or NPN transistors
TEST SIGNAL		50Hz test signal appears between VΩmA and COM jacks
AUDIBLE CONTINUITY		Red lead to VΩmA and COM jacks Black lead to COM



MA-DMTL
TEST LEADS



MA-12361
IMMERSION PROBE
MA-12362
AIR PROBE



MA-DMTL1
PROTECTIVE COVER
TEST LEADS



MA-DMTP
TEMPERATURE
PROBE



MA-DMTK
K-PROBE



MA-DMTKA
ADAPTOR FOR
THE MA-DMTK



MA-DMTK1
K-PROBE WITH
ADAPTOR

FUNCTION	MA-12814	MA-12816A	MA-12823
DCV	1V, 10V, 50V, 250V, 500V	0.1V, 0.5V, 2.5V, 10V, 50V, 250V, 1000V	75V
ACV (50/60Hz)	1V, 10V, 50V, 250V, 500V	10V, 50V, 250V, 1000V	150V, 300V, 750V
DCA	500µA, 50mA, 250mA	50µA, 2.5mA, 25mA, .25A, 10A	
ACA			6A, 15A, 150A, 600A
OHM	Rx 1k (Center 5K)		
TEMPERATURE			-4F TO 300F (-20C TO 150C)
RESISTANCE		x1, x10, x100, x1K, x10K	0-2kΩ, 0-200kΩ
CONTINUITY			
DECIBEL		-10 TO +22dB	
ICEO		150µA, 1.5mA, 15mA	
hFE		0 - 1000	

MA-12814
ANALOG MULTI-METER
 UNIT SIZE: 3-1/2" X 2-1/4"
 INCLUDES :
 MA-DMTL4, MANUAL &
 (1) AA BATTERY

MA-12816A
ANALOG MULTI-METER
 UNIT SIZE: 5-1/2" X 3-3/4"
 INCLUDES:
 MA-DMTL, MANUAL,
 (1) 9V BATTERY & (2) AA BATTERIES

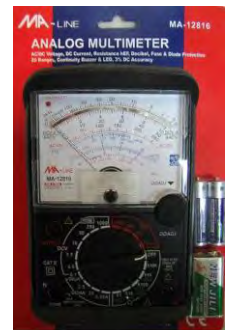

MA-12823
ANALOG CLAMP-ON
METER
WITH TEMPERATURE
 INCLUDES:
 MA-DMTL, CASE, MANUAL
 & (2) AA BATTERIES





MA-12813
DELUXE
DIGITAL
CLAMP-ON
METER



MA-12822B
1000 AMP AC CURRENT
AUTO-RANGING LOW
TEMPERATURE
CLAMP-ON METER

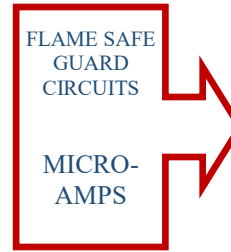

MA-12826B
HVAC DIGITAL
CLAMP-ON METER

BUY 6 AND
GET A
COUNTER
DISPLAY
BOX FREE



MA-3268C
MINI AUTO-RANGING
CLAMP-ON METER



MA-3268WC
MINI AUTO-RANGING
CLAMP-ON METER
WITH CAPACITANCE

BUY 6 AND
GET A
COUNTER
DISPLAY
BOX FREE

FUNCTION	MA-12813	MA-12822B	MA-12826B	MA-3268C	MA-3268WC
DCV	600V	400mV, 4V, 40V, 400V, 700V	600V	200mV - 600V	400mV - 600V
ACV	600V	4V, 40V, 400V, 1000V	600V	2V - 600V	400Mv - 600v
DCA	200A, 600A	400A, 1000A	4000uF		
ACA	200A, 600A	400A. 1000A	400A, 1000A	2A - 400A	40A - 400A
RESISTANCE	2000Ω		400MΩ	200Ω - 20MΩ	400Ω - 40MΩ
TEMP.	-4F TO 2498F (-20C TO 1370C)	-58F TO 1832F (-50C TO 1000C)	-58F TO 2372F (-50C TO 1300C)	-4F to 1400F (-20C to 750C)	-38F to 1750F (-38C to 950C)
OHM		400, 4K, 40K, 400K, 4M, 40M			
CAPACITANCE		40nF, 400nF, 4uF, 40uF, 100uF	100uF		5nF to 200uF
FREQUENCY	50/60Hz	40, 400, 4K, 40K, 400K, 4MHz	150KHz		
CONTINUITY	*	*	*	*	*
DIODE TEST		*	*		
JAW OPENING	1-1/2"	2-1/4"	3/4"	7/8"	7/8"
TEST LEADS	MA-DMTL1	MA-DMTL1	MA-DMTL1	MA-DMTL	MA-DMTL
TEMP. PROBE			MA-DMTP	MA-DMTP	MA-DMTP
BATTERY	(1) 9V	(1) 9V	(2) AAA	(2) AAA	(2) AAA
CASE	*	*	*	*	*



MA-600CFA
ECONOMY
AUTO-RANGING
CLAMP-ON METER



MA-821
DIGITAL
CLAMP-ON
METER



MA-823
DIGITAL CLAMP-ON
METER
WITH TEMPERATURE

FUNCTION	MA-600CFA	MA-821	MA-823
DCV	200mV, 20V, 20V, 200V, 600V	600V	40mV - 600V
ACV	2V, 20V, 200V, 600V	600V	4V - 600V
DCA			
ACA	2A, 20A, 200A, 600A	2A, 20A, 200A, 600A	4A - 600A
RESISTANCE	200Ω, 2kΩ, 20kΩ, 200kΩ, 2MΩ, 20MΩ	20K - 20MΩ	400Ω, 4kΩ, 40kΩ, 400kΩ, 4MΩ, 40MΩ
TEMP.	-38F TO 1750F (-38C TO 950C)		32F TO 752F (0 - 400C)
CAPACITANCE			40nF, 400nF, 4uF, 100uF
FREQUENCY			10HZ - 10MHZ
CONTINUITY		*	
DIODE TEST		*	*
JAW OPENING	1-1/8"	1-1/4"	1-1/4"
TEST LEADS	MA-DMTL1	MA-DMTL1	MA-DMTL1
TEMPERATURE PROBE	MA-DMTK		MA-DMTK1
BATTERY	(1) 9V	(2) AAA	(2) AAA
CASE	*	*	*



MA-12353
AC CURRENT
CLAMP-ON
ADAPTOR
JAW OPENING: 1/2"
RANGE: 200A (AC)
INCLUDES: TEST LEADS



MA-12356
CLAMP-ON
K-TYPE PROBE
THERMOMETER
JAW OPENING 1-1/4"
TEMP:
-40F TO 1100F (-40C TO 590C)



MA-12355B
CLAMP-ON PROBE
K-TYPE
THERMOMETER
JAW OPENING 1-3/8"
TEMP:
-40F TO 392F
(-40C TO 200C)
10' LEAD



MA-12357A
STRAP-ON
K-TYPE PROBE
THERMOMETER
TEMP:
-4F TO 300F (-20C TO 149C)



MA-12358
AC/DC CURRENT
CLAMP-ON
ADAPTOR
JAW OPENING: 1-1/8"
RANGE: 40 TO 400A (AC/DC)
NON-CONTACT VOLTAGE:
50 TO 600 VAC
INCLUDES:
TEST LEADS, CASE &
(2) AAA BATTERIES



FUNCTION	MA-DLSN7
AIR PRESSURE	300 TO 1100hPA
TEMPERATURE	-31F TO 176F (-35C TO 80C)
HUMIDITY	0 TO 100%RH
READING MEMORY	31,998
MEASURING RATE	2 SEC TO 24HR
SOFTWARE	WINDOWS XP/ VISTA/ WINDOWS 7 & 8
BATTERY	(1) 3.6V LITHIUM

**AIR PRESSURE, HUMIDITY &
 TEMPERATURE DATA LOGGER**

MA-DLSN71



INCLUDES: CASE, MANUAL

INCLUDES THE FOLLOWING ACCESSORIES:
 HOOK FOR RECOVERING PARTS
 MAGNET FOR RETRIEVING METALLIC PARTS
 MIRROR FOR SIDE VIEWING

**VIDEO BORESCOPE
 WITH CASE**

MA-VID-1 34" TUBE LENGTH
MA-VID-2 34" TUBE LENGTH PLUS
 10" EXTENSION

SPECIFICATIONS:

WATER RESISTANT IP67
 2.7" TFT RESOLUTION – 960 X 240 PIXELS
 LENS SENSOR RESOLUTION – 640 X 480 PIXELS
 DISPLAY – 2.7" TFT LCD
 DIAMETER OF CAMERA HEAD – 8mm
 WHITE COMPARISON - AUTOMATIC
 EXPOSURE TO LIGHT – AUTOMATIC
 CAMERA ILLUMINATION – 4 WHITE LEDs
 LENS COVERAGE - 54°
 FLEXIBLE GOOSE NECK LENGTH – 34" (88cm)

**MA-MHG-2
 DIFFERENTIAL
 PRESSURE GAUGE
 0 - 2.0 INCHES OF
 WATER COLUMN**



PRESSURE RATING:
 15 PSI(1.03 BAR)
AMBIENT TEMPERATURE RANGE:
 20F TO 140F (-70C TO 60C)



MA-010669
ENVIRONMENTAL KIT

INCLUDES:
(1) MA-AN84A
 MINI ANEMOMETER
(1) MA-12838A
 MINI MANOMETER
1) MA-16531B
 PSYCHROMETER WITH
 WETBULB & DEW POINT

MA-SND80
SOUND LEVEL
METER

LEVEL RANGE:
 LOA = 35-100Db

INCLUDES:
 CASE, MANUAL & (1) 9V
 BATTERY



TEMP.	32F TO 122F (0 TO 50C)
CFM (CFM=ft ³ /min)	0-999.900
Ft./Min.	196-4900
M/S	1.00-25.00
Km/h	3.6-90.0
MPH	2.24-56.0
knots	1.94-48.5

MA-AN84A
DIGITAL MINI ANEMOMETER (CFM)
WITH MAGNET

INCLUDES: CASE, MANUAL, & (1) 9V BATTERY

TEMP.	14F TO 140F (-10C TO 60C)
CFM (CFM=ft ³ /min)	0-999.900
Ft./Min.	119-5900
M/S	.60-30.00
Km/h	2.2-108.00
MPH	1.4 -67.0
knots	1.2-58.0

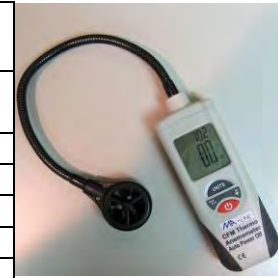

MA-12843B
DIGITAL ANEMOMETER (CFM) WITH
FLEXIBLE NECK

INCLUDES: CASE, MANUAL & (1) 9V BATTERY

MA-12838A

INCLUDES:
 FLEXIBLE
 TUBING,
 1/8" MPT X 1/8"
 BARB ACCESS
 FITTING
 CASE, MANUAL
 & (1) 9V BATTERY



MINI DIGITAL DUAL
DIFFERENTIAL MANOMETER
WITH MAGNET

INCLUDES:
 CASE,
 MANUAL,
 & (1) 9V
 BATTERY

MA-16531C



DIGITAL
PSYCHROMETER
 WITH WET BULB &
 DEW POINT WITH
 MAGNET

-55.40 TO +55.40IN
 OF
 WATER COLUMN

inH2O	±55.40"
psi	±2
mbar	±137.8
kPa	±13.79
inHg	±0.407
mmHg	±103.4
ozin ²	±32.00
ftH2O	±4.612
cmH2O	±140.6
kgcm ²	±.140
bar	±.137

MA-12835B

INCLUDES:
 FLEXIBLE
 TUBING,
 1/8" MPT X 1/8"
 BARB ACCESS
 FITTING
 CASE, MANUAL
 & (1) 9V BATTERY



DIGITAL DUAL DIFFERENTIAL
MANOMETER WITH MAGNET

FUNCTION	MA-16531B	MA-16533
HUMIDITY	0 TO 100% RH	0 TO 100% RH
TYPE K		-58F TO 2501F (-50C TO 1372C)
NTC		32F TO 140F (0 TO 60C)
DEW POINT	-22F TO 212 (-30C TO 100C)	-22F TO 199F (-30C TO 100C)
WET BULB	32F TO 170F (0 TO 80C)	32F TO 176F (0 TO 80C)
TEMP.	-22F TO 212F (-30C TO 100C)	-30F TO 199F (-30C TO 100C)



INCLUDES:
 MA-DMTK, CASE,
 MANUAL,
 & (1) 9V BATTERY

MA-16533

DIAGNOSTIC
PSYCHROMETER
 TARGETS SUPER HEAT
 & EVAPORATOR
 EXIT TEMPERATURE



MA-12830A
CARBON MONOXIDE DETECTOR

0 TO 1000 PPM

INCLUDES:
CASE, MANUAL &
(1) 9V BATTERY

MA-12830A-S
SENSOR ONLY

MA-CO801
CARBON MONOXIDE DETECTOR

TEMPERATURE:
-4F TO 122F (-20C TO 50C)
0 TO 1000 PPM

INCLUDES:
CASE, MANUAL &
(6) AAA BATTERIES



NOMINAL VOLTAGE	40V TO 690V AC
FREQUENCY	2 TO 400Hz

THIS UNIT DETECTS THE ROTARY FIELD OF THREE PHASE SYSTEMS.

MA-12701
DIGITAL PHASE ROTATION INDICATOR

INCLUDES: TEST LEADS, CASE & MANUAL

NOMINAL VOLTAGE	1V TO 400V AC
NOMINAL VOLTAGE PHASE INDICATION	120V TO 400V AC
FREQUENCY	2 TO 400Hz

THIS UNIT DETERMINES MOTOR-ROTATION DIRECTION AND DETECTS THE ROTARY FIELD OF THREE PHASE SYSTEMS.

MA-12702
MOTOR & PHASE ROTATION INDICATOR

INCLUDES: TEST LEADS, CASE & MANUAL



INCLUDES:
LEADS,
MANUAL
& (1) 9V
BATTERY

RANGE	RESOLUTION
200pF	0.1pF
2nF	1pF
20nF	10pF
200nF	100pF
2µF	1nF
20µF	10nF
200µF	100nF
2000µF	1uF
20mF	10uF

MA-12815A
DIGITAL CAPACITOR TESTER
MA-12815A-24
24" TEST LEADS

WATTS AC VOLTAGE (45-60HZ)	0-2000W, 6000W 0-200V, 600V
DCV	0-200V, 1000V
INPUT VOLTAGE/CURRENT	0 TO 600ACV, 1 TO 10ACA
OVERLOAD PROTECTION	600V
INPUT IMPEDANCE	1MΩ

INCLUDES:
MA-DMTL1, CASE, MANUAL
&(1) 9V BATTERY



WATT METER
FOR SINGLE PHASE APPLICATIONS ONLY



MA-12819
OPEN JAW CURRENT AND VOLTAGE METER
DC/AC VOLTAGE & AC CURRENT

FUNCTION	RANGE
DC VOLTAGE	600V
AC VOLTAGE	600V
AC CURRENT	200A
RESISTANCE	240MΩ
CAPACITANCE	200uF
FREQUENCY	9,999MHz
DUTY CYCLE	0.1% - 99.9%
CONTINUITY BUTTON	*
DIODE TEST CURRENT	0.3mA Typical

INCLUDES:
TEST LEADS,
CASE, MANUAL
& (2) AA
BATTERIES

MA-12842A
PHOTO NON-CONTACT TACHOMETER

2.5 TO 99,999 RPM

INCLUDES:
CASE, MANUAL &
(4) AA BATTERIES

MA-12844
REFLECTIVE TAPE STRIPS

IDEAL FOR MEASURING RPM ON MOTORS, GEARS, PULLEYS, COMPRESSORS AND MUCH MORE





CAT IV

MA-7339
PEN STYLE PROBE
DIGITAL
MULTI-METER

NOMINAL VOLTAGE RANGE :
12-600V AC/DC
INDICATION : 100-600V AC
TEST:
3 PHASE F WIRE SYSTEM,
AC 50/60Hz
CONTINUITY : 0-1MΩ

INCLUDES :
MANUAL & (2) AAA
BATTERIES

MA-CGD383
COMBUSTIBLE GAS
DETECTOR

GASOLINE/PROPANE/
NATURAL GAS/METHANE GAS/
FUEL OIL DETECTION

INCLUDES:
SMALL JAR OF LEAK CHECK,
HARD CARRYING CASE, MANUAL
& (4) AA BATTERIES



MA-CGD383-S **MA-CGD383-SP**
SENSOR ONLY **SENSOR PROTECTOR**

MA-EM3213A
PEN PROBE STYLE
AUTO-RANGING DIGITAL
MULTI-METER WITH CAPACITANCE



VOLTAGE DC	200m,2V,20V, 200V, 600V
VOLTAGE AC	2V,20V,200V, 600V
CURRENT DC	20, 200mA
CURRENT AC	20, 200mA
RESISTANCE	4KΩ,40KΩ, 400KΩ, 4MΩ
CAPACITANCE	40n,400n,4μ,4
DIODE TEST	1.5V/.mA
CONTINUITY	*

INCLUDES: MANUAL &
(1) CR2032 (3V) BATTERY

MA-12845A
MICROWAVE LEAK
DETECTOR

CALIBRATED: 2450MHZ
RANGE: 0-9.99 mW/cm²
WARNING VALUE: 5.0mW/cm²
INCLUDES:
CASE, MANUAL & (1) 9V BATTERY

The units LED will flash and alarm will sound when detecting leak above 5mW/cm².



MA-MMD3EA
LCD MOISTURE
INDICATOR FOR
WOOD, DRYWALL
OR CONCRETE

INCLUDES:
REPLACEABLE TEST PROBE
PINS, MANUAL & (1) LR44
BATTERY

MEASURES MOISTURE
FROM 0 TO 100%



MA-EM3215
AUTO-RANGING PROBE STYLE
DIGITAL MULTI-METER



CAT IV 600V

VOLTAGE DC	200m,2V,20V, 200V, 600V
VOLTAGE AC	2V,20V,200V, 600V
CURRENT DC	20, 200mA
CURRENT AC	20, 200mA
RESISTANCE	200,2k,20k,20 0k,2M, 20MΩ
DIODE TEST	*

INCLUDES:
MANUAL & (1) 9V BATTERY

MA-7409
LASER TAPE
MEASURE
MEASURE DISTANCE, HEIGHT,
AREA AND VOLUME

INCLUDES:
CASE, MANUAL &
(1) 9V BATTERY

MEASUREMENT RANGE:
2FT TO 50FT (0.6 TO 15M)
APPROXIMATELY



MA-S3003
POWER METAL/
STUD SENSOR

Electronically locates cables, gas and water pipes. Traces hidden ceiling hoists and wall studs. Helps drilling or sawing. Senses the presence of main power without touching live wires.





MA-IM24-A
RECTANGLE
TELESCOPIC
INSPECTION
MIRROR
WITH 3 LEDS

ADJUSTS TO ANY ANGLE
MIRROR SIZE: 2" X 3-1/4"
LENGTH: 11-1/4"
EXTENDS TO: 34-1/4"

STAINLESS STEEL SHAFT
WITH VINYL GRIP HANDLE

INCLUDES:
(2) CR2032 BATTERIES



MA-IM30-A
ROUND
TELESCOPIC
INSPECTION
MIRROR
WITH 3 LEDS

ADJUSTS TO ANY ANGLE
MIRROR SIZE: 3"
LENGTH: 11-1/8"
EXTENDS TO: 34-1/4"

STAINLESS STEEL SHAFT
WITH VINYL GRIP HANDLE

INCLUDES:
(1) CR2032 BATTERY



MA-149

TELESCOPIC
INSPECTION
MIRRORS



MA-142A
MA-142MA
MA-143A
MA-143M

MA-142A

2-1/4" ROUND MIRROR
EXTENDS TO 20"

MA-142MA

2-1/4" ROUND MIRROR
MAGNIFIED
EXTENDS TO 27"

MA-143A

1-1/4" ROUND MIRROR
EXTENDS TO 25"

MA-143M

1-1/4" ROUND MIRROR
MAGNIFIED
EXTENDS TO 25"

MA-149

2-1/8" X 3-1/2"
RECTANGULAR MIRROR
EXTENDS TO 20"

MA-157A

1" X 2" OVAL MIRROR
EXTENDS TO 25"



MA-157A

STAINLESS STEEL TELESCOPIC
MIRRORS



MA-SM6

1-1/4" X 2" RECTANGLE
13" EXTENDS TO 27"

MA-SM7

2" X 3-3/4" RECTANGLE
14.5" EXTENDS TO 27"

MA-SM8

3-3/4" ROUND
14.5" EXTENDS TO 27"



REPLACEMENT GLASS

MIRROR ONLY

MA-142-1

2-1/4" ROUND

MA-157-1

1" X 2" OVAL

MA-149-1

2-1/8" X 3-1/2" RECTANGLE



MA-16501
HIGH
TEMPERATURE
INFRARED
THERMOMETER



MA-16505A
INFRARED
THERMOMETER
K TYPE PROBE



MA-16506
INFRARED
THERMOMETER
WITH DUAL LASER
TARGETING



MA-16507
INFRARED
THERMOMETER
WITH 16"
FLEXIBLE NECK



MA-16509B
MINI INFRARED
THERMOMETER



MA-16513
LOW
TEMPERATURE
INFRARED
THERMOMETER

FUNCTION	MA-16501	MA-16505A	MA-16506	MA-16507	MA-16509B	MA-16513
TEMP. F/C	-58F ~ 1832F (-50C ~ 1000C)	-58F ~ 1472F (-50C ~ 800C)	-58F ~ 1202F (-50C ~ 650C)	-58F ~ 1112F (-50C ~ 600C)	-58F ~ 1022F (-50C ~ 550C)	-58F ~ 932F (-50C ~ 500C)
K-PROBE		-58F ~ 1472F (-50C ~ 800C)				
RATIO	12:1	12:1	12:1	8:1	12:1	12:1
EMISSIVITY	.95 FIXED	.10 TO 1.0 ADJ.	.1 TO 1.0 ADJ.			.95 FIXED
F/C SWITCHABLE	*	*	*	*	*	*
MAX/MIN/ DIF/AVG RECORD		*				
DATA HOLD	*	*	*	*	*	*
BACKLIGHT	*	*	*	*	*	*
AUTO SHUT OFF	*	*	*	*	*	*
HIGH/LOW ALARM		*				
BATTERY	(1) 9V	(1) 9V	(1) 9V	(1) 9V	(1) 9V	(1) 9V
CASE	*	*	*	*	*	*

NEW!!!

**MA-16550
INFRARED
THERMOMETER**



**MA-16551
INFRARED
THERMOMETER**



**MA-16C81
COLOR INFRARED
THERMOMETER**



**GREEN SCREEN
SETTING OR
READING TEMP.**



**BLUE SCREEN
TEMP. REACHES
BELOW SET TEMP.**



**RED SCREEN
TEMP. REACHES
ABOVE SET TEMP.**



**MA-IR9PEN
POCKET
INFRARED
THERMOMETER**

**BUY 6 AND GET A
COUNTER DISPLAY BOX
FREE**

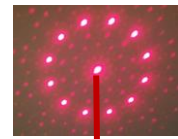

FUNCTION	MA-16550	MA-16551	MA-16C81	MA-IR9PEN
TEMP. F/C	-58F ~ 1022F (-50C ~ 550C)	50F ~ 1900F (-45C ~ 1035C)	-36F ~ 968F (-38C ~ 520C)	-27F ~ 932F (-33C ~ 500C)
K-PROBE				
RATIO	12:1	50:1	8:1	9:1
EMISSIVITY	.10 TO 1.0	.10 TO 1.0 ADJ.		
F/C SWITCHABLE	*	*	*	*
MAX/MIN/ DIF/AVG RECORD	*	*		*
DATA HOLD	*	*		
BACKLIGHT	*	*	*	*
AUTO SHUT OFF	*		*	
HIGH/LOW ALARM	*	*		
BATTERY	(2) AAA	(1) 9V	(2) AAA	(1)AA
CASE		*	*	



MA-DMT123
DUAL PROBE DIGITAL THERMOMETER

TEMPERATURE RANGE:
-328F TO 2498F (-200C TO 1370C)
F/C SWITCHABLE
4" LCD DUAL DISPLAY
RELATIVE FUNCTIONS, MIN,
MAX, AVG, HOLD

GREAT FOR SUPER HEAT

INCLUDES: (2) MA-DMTK, CASE,
MANUAL & (1) 9V BATTERY

MA-DMT123KIT
DUAL PROBE DIGITAL THERMOMETER KIT (SUPER HEAT KIT)

INCLUDES:
1) MA-DMT123
2) MA-DMTK K-TYPE PROBES
2) MA-12355B WITH 10' LEADS



MA-16532

2 IN 1 DIGITAL HUMIDITY AND TEMPERATURE METER

TEMPERATURE RANGE:
-4F TO 140F (-20C TO 60C)
HUMIDITY: 0 TO 100% RH
F/C SWITCHABLE
MIN, MAX, DATA HOLD FUNCTION
DUAL LCD DISPLAY
AUTO POWER OFF
BACKLIGHT BUTTON
INCLUDES:
CASE, MANUAL & (1) 9V BATTERY



MA-RT900A
HAND HELD DIGITAL THERMOMETER

TEMPERATURE RANGE:
-58F TO 392F (-50C TO 200C)
F/C SWITCHABLE
WIDE MEASUREMENT RANGE
MIN/MAX TEMPERATURE MEMORY
DATA HOLD FUNCTION
STAINLESS STEEL PROBE
MAGNET ON BACK & FOLDING STAND
NEVER NEEDS TO BE CALIBRATED

INCLUDES: (1) AAA BATTERY

MA-RT343
ROTARY PROBE POCKET DIGITAL THERMOMETER

TEMPERATURE RANGE:
-58F TO 392F (-50C TO 200C)
F/C SWITCHABLE
WIDE MEASUREMENT RANGE
MIN/MAX TEMPERATURE MEMORY
DATA HOLD FUNCTION
STAINLESS STEEL PROBE - 4-1/2"
ROTARY PROBE DESIGN
HIGH/LOW TEMPERATURE ALARM SETTING
FOR USE IN FOOD PROCESSING,
REFRIGERATION, LABORATORY &
GREENHOUSE

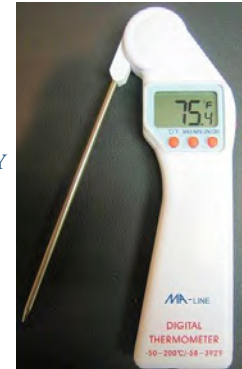

INCLUDES:
(1) AAA BATTERY

DIGITAL THERMOMETER 180 DEGREE ROTATING HEAD



INCLUDES:
(1) 1.5V BATTERY

TEMPERATURE RANGE:
-58F TO 302F (-50C TO 150C)
ON/OFF SWITCH AND AUTOMATIC SHUT OFF AFTER 10 MIN.
IT'S UNIQUE FEATURE IS THE 180° ROTATING HEAD

MA-RT340 WITH 5" STEM
MA-RT340LS WITH 8" STEM



INCLUDES:
(1) 1.5V BATTERY

TEMPERATURE RANGE:
-58F TO 302F (-50C TO 150C)
F/C SWITCHABLE
ON/OFF SWITCH
AUTOMATIC SHUT OFF AFTER 10 MIN.

MA-RT330
DIGITAL THERMOMETER
ANTI-ROLLING DESIGN

INCLUDES:
(2) 1.5V BATTERY



MA-RT335
DIGITAL THERMOMETER
ANTI-ROLLING OVAL DESIGN

TEMPERATURE RANGE:
-58F TO 392F (-53C TO 200C)
F/C SWITCHABLE
ON/OFF SWITCH



INCLUDES:
(1) 1.5V BATTERY
**BUY 12 AND GET A
COUNTER DISPLAY BOX
FREE**



**MA-PDT392B (1/PKG.)
DIGITAL POCKET THERMOMETER**

F/C SWITCHABLE
STAINLESS STEEL STEM
ON/OFF SWITCH – AUTO OFF
HIGH/LOW TEMPERATURE RECALL
DATA HOLD
WATER RESISTANCE
TEMP. RANGE:
-40F TO 392F (-40C TO 200C)



**TEMP.
RANGE:**
32F TO 122F
(0 TO 50C)

INCLUDES:
(1) AAA
BATTERY

**MA-RT819
BIG DIGIT PEN SHAPE
HYGRO THERMOMETER**
F/C SWITCHABLE - MAX/MIN READING
MEMORY -
DUAL DISPLAY FOR TEMPERATURE
& HUMIDITY

**MA-ST200
PIPING
THERMOMETER**

TEMPERATURE RANGE:
-50F TO 250F (-40C TO 120C)

2 DIAL SPRING MOUNTED OR
SURFACE THERMOMETER

DESIGNED TO MEASURE
SURFACE TEMPERATURES
OF PIPES, CYLINDERS,
SPINDLES, ETC.
BETWEEN 3/4" OD TO 6" OD

KIT INCLUDES:
2 CLASP AND 3 DIFFERENT
SIZES OF HIGHLY RESILIENT
STAINLESS STEEL



**ADJUSTABLE POCKET
THERMOMETERS**

WITH CASE AND 5" STEM

MA-PT160 (12/CASE)

MA-PT160B (1/PKG)

1" DIAL -40F TO 160F

MA-PT220 (12/CASE)

MA-PT220B (1/PKG)

1" DIAL 0 TO 220F

MA-PT550 (12/CASE)

1" DIAL 50F TO 550F

MA-PT70C (12/CASE)

1" DIAL -40C TO 70C

MA-PT110C (12/CASE)

1" DIAL -10C TO 110C

MA-PT138160 (12/CASE)

1-3/8" DIAL -40F TO 160F

MA-PT138220 (12/CASE)

1-3/8" DIAL 0 TO 220F

MA-PT134160 (1/PKG)

1-3/4" DIAL -40F TO 160F

MA-PT134220 (1/PKG)

1-3/4" DIAL 0 TO 220F

POCKET STICK THERMOMETER



MA-PS120 -40F TO 160F (12/CTN)

MA-PS220 0F TO 220F (12/CTN)

FAHRENHEIT SCALE – 5" IN LENGTH – SPIRIT FILLED

INDOOR/OUTDOOR THERMOMETER WITH CLOCK

INSTANT F/C SWITCH –
WALL MOUNT OR TABLE DESIGN –
TIME, DATE DISPLAY & ALARM –
12/24 HOURS SYSTEM CLOCK
INCLUDES: (1) AAA BATTERY



MA-BDIOT
INDOOR/OUTDOOR TEMP:
-4F TO 122F (-20C TO 50C)

MA-BDHTR
INDOOR/OUTDOOR TEMP:
-58F TO 158F (-50C TO 70C)
HUMIDITY: 20% TO 90%

MA-ETP110
HUMIDITY ALARM
MEASURES TEMPERATURE,
RELATIVE HUMIDITY, AND DEW
POINT

TEMP. RANGE:
14F TO 140F (-10C TO 60C)
HUMIDITY: 20% TO 95%
DEW POINT:
-20.2F TO 138.2F (-29C TO 59C)
(2) AAA BATTERIES NOT INCLUDED



MA-1660A
FREEZER ALERT
ALARM SOUNDS WHEN FOOD
STARTS TO DEFROST
112" TEMP. PROBE
INCLUDES: (1) AA BATTERY

MA-1665C
FLOOD ALERT
DETECTS WATER OVERFLOW.
112" SENSOR CABLE
INCLUDES: (1) AA BATTERY



MA-RT1
REFRIG./FREEZER THERMOMETER
TEMPERATURE RANGE:
-20F TO 80F (-30C TO 30C)
MA-OVN1
OVEN THERMOMETER
TEMPERATURE RANGE:
100F TO 550F (-50C TO 300C)



MA-SUT45
STICK-UP THERMOMETER
TEMPERATURE RANGE:
-20F TO 120F (-30C TO 50C)



MA-1001S
SOLAR HORIZONTAL THERMOMETERS
TEMPERATURE RANGE:
-58F TO 302F (50C TO 150C)
F/C SWITCHABLE
48" CAPILLARY
1-1/2" X 1/2" DISPLAY

MA-HRFT1
HORIZONTAL REFRIG./FREEZER THERM.
TEMPERATURE RANGE:
-40F TO 80F (-40C TO 30C)



MA-RT8101
SOLAR POWERED DIGITAL THERMOMETER
TEMPERATURE RANGE:
INTERNAL SENSOR:
32F TO 122F (0 TO 50C)
EXTERNAL SENSOR:
-58F TO 158F (-50 TO 70C)
F/C SWITCHABLE
MAX/MIN MEMORY

MA-RT8100
DUAL PROBE FRIDGE/FREEZER THERMOMETER WITH ALARM
TEMPERATURE RANGE:
-40F TO 158F (-40C TO 70C)
F/C SWITCHABLE
ALARM – DUAL DISPLAY
MIN/MAX MEMORY
MAGNET, DESK STAND & TWO SUCTIONS CUPS



REMOTE READING SOLAR THERMOMETERS

TEMPERATURE RANGE:
-58F TO 302F (-50C TO 150C)
F/C SWITCHABLE
ALL STAINLESS STEEL CASE

MA-2001S
2" DIAL, FRONT FLANGE, W/48"
MA-2002S
2" DIAL, BACK FLANGE, W/48"
MA-2003S 2" DIAL U-CLAMP, W/48" CAPILLARY



REMOTE READING VAPOR TENSION THERMOMETERS

TEMPERATURE RANGE:
-40F TO 60F (-40C TO 15C)
ALL STAINLESS STEEL CASE

MA-50ABF
2" DIAL, BACK FLANGE, W/60" CAPILLARY
MA-60A
2-1/2" DIAL, STRAP MOUNT, W/60" CAPILLARY
MA-60AFF-A 2" DIAL, FRONT FLANGE, W/60" CAPILLARY





CLEAR VINYL TUBING

MA-CVT316 3/16"ID X 100'
MA-CVT14 1/4"ID X 100'
MA-CVT38 3/8"ID X 100'
MA-CVT12 1/2"ID X 100'

MA-CVT58 5/8"ID X 100'
MA-CVT34 3/4"ID X 100'
MA-CVT78 7/8"ID X 50'
MA-CVT1 1"ID X 50'

HEAVY DUTY BRAIDED TUBING

MA-HDT316 3/16"ID X 50'
MA-HDT14 1/4"ID X 50'
MA-HDT38 3/8"ID X 50'
MA-HDT12 1/2"ID X 50'
MA-HDT58 5/8"ID X 50'
MA-HDT34 3/4"ID X 50'
MA-HDT78 7/8"ID X 50'
MA-HDT1 1"ID X 50'



5' SQUARE BLACK NEOPRENE TUBING
MA-SNAT316-5

BLACK NEOPRENE AIR TUBING

MA-NAT18-5 1/8"ID X 5'
MA-NAT316-5 3/16"ID X 5'
MA-NAT316 3/16"ID X 100'



ALUMINUM TUBING 5' KIT
INCLUDES FITTINGS

MA-AT14-5 1/4"
MA-AT18-5 1/8"
MA-AT316-5 3/16"
MA-AT38-5 3/8"

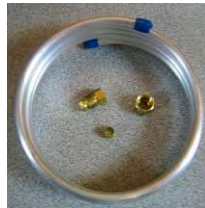

RED SILICONE RUBBER TUBING

MA-SRT18-5 1/8"ID X 5/16"OD
MA-SRT316-5 3/16"ID X 5/16"OD
MA-SRT14-5 1/4"ID X 3/8"OD



5' LENGTH

50' COILS ALUMINUM TUBING
WITHOUT FITTINGS

MA-AT18 1/8"OD **MA-AT38** 3/8"OD
MA-AT316 3/16"OD **MA-AT716** 7/16"OD
MA-AT14 1/4"OD **MA-AT12** 1/2"OD
MA-AT516 5/16"OD **MA-AT58** 5/8"OD

ASTM: B483
ALLOY: 3003
WALL THICKNESS: .035

MA-PT14 POLYETHYLENE TUBING

MA-PT14 1/4"OD X 100'
MA-PT38 3/8"OD X 100'
MA-PT516 5/16"OD X 100'

RUBBER DRAIN LINE ELBOWS

MA-38RUEL 3/8" I.D.
MA-34RUEL 3/4" I.D.



FOR QUICK DISCONNECT AND RECONNECT OF DRAIN LINE

PILOT LIGHT (BREAKAWAY) FITTINGS

181SP-02 1/8"
181SP-03 3/16"
181SP-04 1/4"
181SP-06 3/8"

Nut with breakaway sleeve screws into gas control valves for furnaces, water heaters, etc.
Fittings are sold individually.



COMBO-HEX CLAMP

5/16" HEX HEAD COLLARED SCREW
ZINC-PLATED CARBON STEEL SCREW
300 STAINLESS BAND & HOUSING

10/BOX - SOLD PER BOX

- MA-5406BX** SIZE 06, 1/2" TO 7/8" DIA.
- MA-5408BX** SIZE 08, 9/16" TO 1" DIA.
- MA-5410BX** SIZE 10, 11/16" TO 1-1/16" DIA.
- MA-5412BX** SIZE 12, 11/16" TO 1-1/4" DIA.
- MA-5416BX** SIZE 16, 13/16" TO 1-1/2" DIA.
- MA-5420BX** SIZE 20, 13/16" TO 1-3/4" DIA.
- MA-5428BX** SIZE 28, 1-5/16" TO 2-1/4" DIA.
- MA-5432BX** SIZE 32, 1-9/16" TO 2-1/2" DIA.
- MA-56188** SIZE 188, 11" TO 12" DIA.



MICRO GEAR HOSE CLAMP

5/16" HEX HEAD
ZINC-PLATED CARBON STEEL SCREW
300 STAINLESS BAND & HOUSING
TINY BUT TOUGH

10/BOX - SOLD PER BOX

- MA-6202BX** SIZE 04, 1/4" TO 5/8" DIA.
- MA-6203BX** SIZE 06, 5/16" TO 7/8" DIA.
- MA-6204BX** SIZE 12, 3/4" TO 1-1/4" DIA.
- MA-6205BX** SIZE 16, 13/16" TO 1-1/2" DIA.
- MA-6206BX** SIZE 20, 7/8" TO 1-3/4" DIA.

HANGING WIRE

HWA = TENSILE STRENGTH - 60,000 - 75,000
HWG = TENSILE STRENGTH - 95,000 - 115,000

18 GAUGE

- MA-HWA02** 2LB. BLACK ANNEALED
- MA-HWA05** 5LB. BLACK ANNEALED
- MA-HWG02** 2LB. GALVANIZED WIRE
- MA-HWG05** 5LB. GALVANIZED WIRE

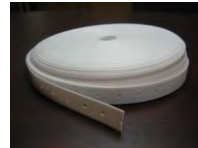

PLASTIC HANGING STRAP

- MA-PH50** 3/4" X 50'
- MA-PH100** 3/4" X 100'

USED AS PIPE HANGER, DUCT HANGER, TUBING STRAP AND UTILITY STRAP

PERFORATED STRAPS 20 GAUGE

- MA-GF1** 3/4" X 10' GALVANIZED
- MA-GF-50** 3/4" X 50' GAL.
- MA-GF-100** 3/4" X 100' GAL.
- MA-CF1** 3/4" X 10' COPPER
- MA-CF-50** 3/4" X 50' COPPER
- MA-CF-100** 3/4" X 100' COPPER



J-HOOKS

20 GAUGE



25 PER BAG

DRAIN PIPE HOLDER

- MA-J1500** 1-1/2"
- MA-J2000** 2"
- MA-J3000** 3"
- MA-J4000** 4"
- SWIVEL ADJ. HANGER**
- MA-SH1500** 1-1/2"
- MA-SH2000** 2"
- MA-SH3000** 3"
- MA-SH4000** 4"

The hangers hold pipe firmly and it eliminates noise from vibrating pipes. Includes nails to prevent soldering and eliminates hanger/pipe corrosion and electrolysis. The SH series has a rotating feature to hang pipe on an angle.

1-HOLE PIPE CLAMPS

HANGING THINWALL CONDUIT
GALVANIZED

- MA-DT12** 1/2" ID (100/PKG)
- MA-DT34** 3/4" ID (100/PKG)
- MA-DT1** 1" ID (100/PKG)
- MA-DT114** 1-1/4" ID (50/PKG)
- MA-DT112** 1-1/2" ID (50/PKG)
- MA-DT2** 2" ID (25/PKG)



- MA-10DT12** 1/2" ID (10/PKG)
- MA-10DT34** 3/4" ID (10/PKG)
- MA-5DT1** 1" ID (5/PKG)
- MA-5DT114** 1-1/4" ID (5/PKG)
- MA-5DT112** 1-1/2" ID (5/PKG)

2-HOLE TUBING CLAMPS

HANGING THINWALL CONDUIT

- MA-BT12** 1/2" ID (100/PKG)
- MA-BT34** 3/4" ID (100/PKG)
- MA-BT1** 1" ID (100/PKG)
- MA-BT114** 1-1/4" ID (50/PKG)
- MA-BT112** 1-1/2" ID (50/PKG)
- MA-BT2** 2" ID (25/PKG)

GALVANIZED



COPPER



HANGING COPPER TUBING

- MA-BC14** 1/4" ID (500/PKG)
- MA-BC38** 3/8" ID (500/PKG)
- MA-BC12** 1/2" ID (250/PKG)
- MA-BC34** 3/4" ID (150/PKG)
- MA-BC1** 1" ID (100/PKG)
- MA-BC114** 1-1/4" ID (50/PKG)
- MA-BC112** 1-1/2" ID (50/PKG)
- MA-BC2** 2" ID (25/PKG)

CONDUIT PIPE CLAMPS WITH BOLTS

- MA-K12** 1/2" ID (100/PKG) HANGING CONDUIT OR IRON PIPE
- MA-K34** 3/4" ID (100/PKG)
- MA-K1** 1" ID (100/PKG)
- MA-K114** 1-1/4" ID (100/PKG)
- MA-K112** 1-1/2" ID (100/PKG)
- MA-K2** 2" ID (50/PKG)
- MA-K212** 2-1/2" ID (50/PKG)
- MA-K3** 3" ID (25/PKG)



WIRE PIPE HANGERS



9 GAUGE WIRE
50/BOX

HANGING BLACK IRON PIPE

- MA-NW124** 1/2" X 4"
- MA-NW126** 1/2" X 6"
- MA-NW344** 3/4" X 4"
- MA-NW346** 3/4" X 6"
- MA-NW16** 1" X 6"

HANGING COPPER TUBE

- MA-NW124-C** 1/2" X 4"
- MA-NW126-C** 1/2" X 6"
- MA-NW344-C** 3/4" X 4"
- MA-NW346-C** 3/4" X 6"
- MA-NW16-C** 1" X 6"

**BUSS FUSES
 DUAL ELEMENT
 TIME DELAY, 250V,
 CLASS RK5 FUSES**

PART #	AMP	PKG
MA-FRNR1	1	10
MA-FRNR1.25	1.25	10
MA-FRNR1.6	1.6	10
MA-FRNR2	2	10
MA-FRNR2.5	2.5	10
MA-FRNR3.2	3.2	10
MA-FRNR4	4	10
MA-FRNR5	5	10
MA-FRNR6.25	6.25	10
MA-FRNR8	8	10
MA-FRNR10	10	10
MA-FRNR12	12	10
MA-FRNR15	15	10
MA-FRNR20	20	10
MA-FRNR25	25	10
MA-FRNR30	30	10
MA-FRNR35	35	10
MA-FRNR40	40	10
MA-FRNR45	45	10
MA-FRNR50	50	10
MA-FRNR60	60	10
MA-FRNR70	70	5
MA-FRNR80	80	5
MA-FRNR90	90	5
MA-FRNR100	100	5
MA-FRNR110	110	1
MA-FRNR125	125	1
MA-FRNR150	150	1
MA-FRNR175	175	1
MA-FRNR200	200	1
MA-FRNR225	225	1

**BUSS FUSES
 DUAL ELEMENT
 TIME DELAY, 600V,
 CLASS RK5 FUSES**

PART #	AMP	PKG
MA-FRSR1	1	10
MA-FRSR1.25	1.25	10
MA-FRSR1.6	1.6	10
MA-FRSR2	2	10
MA-FRSR2.5	2.5	10
MA-FRSR3.2	3.2	10
MA-FRSR4	4	10
MA-FRSR5	5	10
MA-FRSR6.25	6.25	10
MA-FRSR8	8	10
MA-FRSR10	10	10
MA-FRSR12	12	10
MA-FRSR15	15	10
MA-FRSR20	20	10
MA-FRSR25	25	10
MA-FRSR30	30	10
MA-FRSR35	35	10
MA-FRSR40	40	10
MA-FRSR45	45	10
MA-FRSR50	50	10
MA-FRSR60	60	10
MA-FRSR70	70	5
MA-FRSR80	80	5
MA-FRSR90	90	5
MA-FRSR100	100	5
MA-FRSR110	110	1
MA-FRSR125	125	1
MA-FRSR150	150	1
MA-FRSR175	175	1
MA-FRSR200	200	1
MA-FRSR225	225	1

**BUSS HEATING
 & A/C FUSES
 TIME DELAY, 250V
 CURRENT LIMITING,
 CLASS RK5,
 UL LISTED,
 CSA CERTIFIED**

PART #	AMP	PKG
MA-ECNR3.2	3.2	10
MA-ECNR5	5	10
MA-ECNR6.25	6.25	10
MA-ECNR10	10	10
MA-ECNR15	15	10
MA-ECNR20	20	10
MA-ECNR25	25	10
MA-ECNR30	30	10
MA-ECNR35	35	10
MA-ECNR40	40	10
MA-ECNR45	45	10
MA-ECNR50	50	10
MA-ECNR60	60	10
MA-ECNR70	70	5
MA-ECNR80	80	5
MA-ECNR100	100	5
MA-ECNR125	125	1
MA-ECNR200	200	1

**BUSS HEATING
 & A/C FUSES
 TIME DELAY, 600V
 CURRENT LIMITING,
 CLASS RK5,
 UL LISTED,
 CSA CERTIFIED**

PART #	AMP	PKG
MA-ECSR10	10	10
MA-ECSR15	15	10
MA-ECSR20	20	10
MA-ECSR25	25	10
MA-ECSR30	30	10
MA-ECSR35	35	10
MA-ECSR40	40	10
MA-ECSR45	45	10
MA-ECSR50	50	10
MA-ECSR60	60	10
MA-ECSR70	70	5
MA-ECSR80	80	5
MA-ECSR90	90	5
MA-ECSR100	100	5
MA-ECSR125	125	5
MA-ECSR150	150	1
MA-ECSR200	200	1

BUSS ONE TIME FUSE 250 VOLT

PART #	AMP	PKG
MA-NON1	1	10
MA-NON3	3	10
MA-NON6	6	10
MA-NON10	10	10
MA-NON15	15	10
MA-NON20	20	10
MA-NON25	25	10
MA-NON30	30	10
MA-NON35	35	10
MA-NON40	40	10



PART #	AMP	PKG
MA-NON45	45	10
MA-NON50	50	10
MA-NON60	60	10
MA-NON70	70	5
MA-NON80	80	5
MA-NON100	100	5
MA-NON150	150	1
MA-NON175	175	1
MA-NON200	200	1

**BUSS S PLUG FUSES
 TIME DELAY, 250 VOLT**

PART #	AMP	PKG
MA-S1A	1	4
MA-S11/4A	1.25	4
MA-S16A	1.6	4
MA-S2A	2	4
MA-S21/2A	2.5	4
MA-S32	3.2	4
MA-S4A	4	4
MA-S5A	5	4



PART #	AMP	PKG
MA-S6A	6	4
MA-S61/4A	6.25	4
MA-S8A	8	4
MA-S10A	10	4
MA-S12A	12	4
MA-S15A	15	4
MA-S20A	20	4
MA-S25A	25	4
MA-S31A	30	4

PART #	AMP	PKG
MA-16SA	1.6	4
MA-21/2SA	2.5	4
MA-32SA	3.2	4
MA-61/4SA	6.25	4
MA-15SA	15	4
MA-20SA	20	4
MA-30SA	30	4



**TYPE S
 FUSE
 ADAPTOR**

**BUSS T PLUG FUSES
 TIME DELAY, 250 VOLT**

PART #	AMP	PKG
MA-T1A	1	4
MA-T11/4A	1.25	4
MA-T16A	1.6	4
MA-T2A	2	4
MA-T21/2A	2.5	4
MA-T32A	3.2	4
MA-T4A	4	4
MA-T5A	5	4



PART #	AMP	PKG
MA-T61/4A	6.25	4
MA-T7A	7	4
MA-T8A	8	4
MA-T10A	10	4
MA-T12A	12	4
MA-T15A	15	4
MA-T20A	20	4
MA-T25A	25	4
MA-T30A	30	4

**BUSS SL & TL PLUG FUSES
 TIME DELAY, 250 VOLT**

PART #	AMP	PKG
MA-SL15A	15	4
MA-SL20A	20	4
MA-SL25A	25	4
MA-SL30A	30	4



PART #	AMP	PKG
MA-TL15A	15	4
MA-TL20A	20	4
MA-TL25A	25	4
MA-TL30A	30	4

**BUSS W PLUG FUSES
 TIME DELAY, 250 VOLT**



PART #	AMP	PKG
MA-W3A	3	4
MA-W5A	5	4
MA-W6A	6	4
MA-W8A	8	4
MA-W10A	10	4

IN LINE FUSE HOLDER



- MA00014-1** (2/PKG)
18 GAUGE WITH 15 AMP FUSE
- MA00030-1** (2/PKG)
12 GAUGE WITH 30 AMP FUSE

1/4" X 1-1/4" CERAMIC FUSES
UL LISTED,
CSA CERTIFICATION



PART #	AMP	VOLT	PKG
MA-ABC-1	1	250	5
MA-ABC-2	2	250	5
MA-ABC-3	3	250	5
MA-ABC-5	5	250	5
MA-ABC-6	6	250	5
MA-ABC-8	8	250	5
MA-ABC-10	10	250	5
MA-ABC-12	12	250	5
MA-ABC-15	15	250	5
MA-ABC-20	20	250	5
MA-ABC-30	30	250	5

BLADE – TYPE FUSES

FAST ACTING
32V, DC, UL LISTED



PART #	AMP	VOLT	PKG
MA-ATC2	2	32	5
MA-ATC3	3	32	5
MA-ATC4	4	32	5
MA-ATC5	5	32	5
MA-ATC7.5	7.5	32	5
MA-ATC10	10	32	5
MA-ATC15	15	32	5
MA-ATC20	20	32	5
MA-ATC25	25	32	5
MA-ATC30	30	32	5

FUSE REDUCERS

- MA-263-R** FOR CLASS R FUSES
250V, FUSE SIZE 30A
DESIRED SIZE 60A
- MA-263** FOR CLASS H & K FUSES
250V, FUSE SIZE 30A
DESIRED SIZE 60A
- MA-213** FUSE REDUCER



TIME DELAYS

- MA-30301** DELAY ON MAKE
- MA-30303** DELAY ON BREAK

BUSSMANN BOX-COVER UNITS



Fuse Holder and Switch units provide both protection for the motor and the switch for turning the device on and off

10/BOX
PRICE PER PIECE

- MA-SSU** COVER FOR 2-1/4" HANDY BOX
- MA-SSW** COVER FOR 2-3/4" SWITCH BOX
- MA-SSX** COVER FOR 4" OCTAGON BOX
- MA-SSY** COVER FOR 4" SQUARE BOX

- MA-SRU** COVER FOR 2-1/4" HANDY BOX
- MA-SRY** COVER FOR 4" SQUARE BOX

Fuse Holder and Plug-In Receptacle units provide convenient and unique protection for devices permanently connected to a circuit where switch control is desired. The grounding type Plug-In Receptacle uses either ordinary 2-prong attachment plug caps, a 2-prong parallel polarized cap with (1) wide prong, or a 3-prong grounding type cap. These units are intended for use on maximum 3/4HP and 125V

1/4" X 1-1/4" GLASS FUSES
TIME DELAY, 250V/32V - CSA CERTIFICATION

PART #	AMP	VOLT	PKG	PART #	AMP	VOLT	PKG
MA-MDL-1/4	1/4	250	5	MA-MDL-5	5	250	5
MA-MDL-1/2	1/2	250	5	MA-MDL-6	6	250	5
MA-MDL-3/4	3/4	250	5	MA-MDL-7	7	250	5
MA-MDL-1	1	250	5	MA-MDL-8	8	250	5
MA-MDL-1-1/4	1-1/4	250	5	MA-MDL-10	10	32	5
MA-MDL-2	2	250	5	MA-MDL-15	15	32	5
MA-MDL-2-1/2	2-1/2	250	5	MA-MDL-20	20	32	5
MA-MDL-3	3	250	5	MA-MDL-25	25	32	5
MA-MDL-3.2	3-2/10	250	5	MA-MDL-30	30	32	5
MA-MDL-4	4	250	5				

CLASS G FUSE

TIME DELAY, 480V - UL LISTED, CSA CERTIFIED

PART #	AMP	VOLT	PKG	PART #	AMP	VOLT	PKG
MA-SC10	10	480	10	MA-SC35	35	480	10
MA-SC15	15	480	10	MA-SC40	40	480	10
MA-SC20	20	480	10	MA-SC45	45	480	10
MA-SC25	25	480	10	MA-SC50	50	480	10
MA-SC30	30	480	10	MA-SC60	60	480	10

FUSE PULLER

MA-7519

OVERALL LENGTH 7"
1/2" DIA & 3/8" DIA.
CARTRIDGE TYPE FUSES
0 TO 200A, 250V



1/4" X 1-1/4" GLASS FUSES

UL LISTED –
CSA CERTIFICATION

PART #	AMP	VOLT	PKG
MA-AGC-1/32	1/32	250	5
MA-AGC-1/4	1/4	250	5
MA-AGC-1/2	1/2	250	5
MA-AGC-3/4	3/4	250	5
MA-AGC-1	1	250	5
MA-AGC-1-1/4	1-1/4	250	5
MA-AGC-1-1/2	1-1/2	250	5
MA-AGC-2	2	250	5
MA-AGC-2-1/2	2-1/2	250	5
MA-AGC-3	3	250	5
MA-AGC-4	4	250	5
MA-AGC-5	5	250	5
MA-AGC-6	6	250	5
MA-AGC-7	7	250	5
MA-AGC-8	8	250	5
MA-AGC-9	9	250	5
MA-AGC-10	10	250	5
MA-AGC-15	15	250	5
MA-AGC-20	20	250	5
MA-AGC-25	25	250	5
MA-AGC-30	30	250	5

1/32" X 1-1/2" SUPPLEMENTARY FUSES

TIME DELAY, 250V/500V
UL LISTED, CSA CERTIFIED

PART #	AMP	VOLT	PKG
MA-FNM10	10	250	10
MA-FNM12	12	250	10
MA-FNM15	15	250	10
MA-FNM20	20	250	10
MA-FNM25	25	250	10
MA-FNM30	30	250	10
MA-FNM35	35	250	10
MA-FNM40	40	250	10
MA-FNQ10	10	500	10
MA-FNQ12	12	500	10
MA-FNQ15	15	500	10
MA-FNQ20	20	500	10
MA-FNQ25	25	500	10
MA-FNQ30	30	500	10





**WORLD SOURCE A/C
 METAL DISCONNECTS**

UL & CUL LISTED
 240 VAC, SINGLE PHASE, NEMA TYPE 3R,
 OUTDOOR ENCLOSURE
 12 PER CASE - SOLD PER CASE

- MA-WSFD30A** 30A, FUSED
MA-WSNF60A 60A, NON-FUSED
MA-WSFD60A 60A, FUSED



A/C WHIPS

KIT COMES WITH
 2 REDUCING WASHERS
 ASSEMBLED WITH
 UL APPROVED COMPONENTS

METAL FITTINGS:

- MA-4012W**
 1/2" X 4' #10 THHN WIRE
 FITTINGS: 1 STRAIGHT + 1 90
MA-6012W
 1/2" X 6' #10 THHN WIRE
 FITTINGS: 1 STRAIGHT + 1 90
MA-4034W
 3/4" X 4' #8 THHN WIRE
 FITTINGS: 1 STRAIGHT + 1 90
MA-6034W
 3/4" X 6' #8 THHN WIRE
 FITTINGS: 1 STRAIGHT + 1 90

PLASTIC FITTINGS:

- MA-P4012W**
 1/2" X 4' #10 THHN WIRE
 FITTINGS: 1 STRAIGHT + 1 90
MA-P6012W
 1/2" X 6' #10 THHN WIRE
 FITTINGS: 1 STRAIGHT + 1 90
MA-P4034W
 3/4" X 4' #8 THHN WIRE
 FITTINGS: 1 STRAIGHT + 1 90
MA-P6034W
 3/4" X 6' #8 THHN WIRE
 FITTINGS: 1 STRAIGHT + 1 90



**A/C DISCONNECTS
 WITH GFI OUTLET**

1/CASE - SOLD PER CASE
MA-UO65P010



**3 PHASE
 DISCONNECTS**

240 VAC, THREE PHASE,
 NEMA TYPE 3R,
 OUTDOOR ENCLOSURE
 1/CASE - SOLD PER CASE
 UL & CSL LISTED

- MA-60NF3** 60A, NON-FUSED
MA-30F3 30A, FUSED
MA-60F3 60A, FUSED

**"EXTRA-BOOST"
 HARD START KITS**

These units can increase starting torque from 300% to over 600% depending on the model used. They can be used on room A/C, all residential and commercial PSC A/C units and heat pumps. They can be used on units rated from 4,000 to 120,000 BTU's and they can be used on 120 through 288 VAC units. All models are UL recognized and are for low voltage and hard starting compressors. All units contain a start capacitor and relay for extra starting torque. Installs in seconds across run capacitor terminals.

Voltage: 120 230 Residential/Commercial

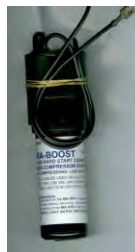

- MA-XP5** BTU 4,000-60,000
MA-XP6 BTU 4,000-120,000
MA-XP8 BTU 4,000-120,000

**NSA'S FURNACE
 MOUNTING BLOCK**

MA-68150
 PATENT #
 8,262,054, 8,882,075
 & D465022



LIQUID TIGHT FITTINGS

METALLIC AND NON-METALLIC



**METALLIC STRAIGHT
 CONNECTOR**

- MA-E50A** 1/2" (10/BOX)
MA-4E50A 1/2" (4/PKG)
MA-E75 3/4" (25/BOX)
MA-4E75 3/4" (4/PKG)
MA-E100 1" (5/PKG)



**METALLIC 90 DEGREE
 ELBOW**

- MA-E5090A** 1/2" (10/BOX)
MA-4E5090A 1/2" (4/PKG)
MA-E7590 3/4" (25/BOX)
MA-4E7590 3/4" (4/PKG)
MA-E10090 1" (5/BOX)



**NON-METALLIC
 STRAIGHT CONNECTOR**

- MA-LC43D** 1/2" SCREW ON (10/BOX)
MA-4LC43D 1/2" SCREW ON (4/PKG)
MA-LC43E 3/4" SCREW ON (10/BOX)
MA-4LC43E 3/4" SCREW ON (4/PKG)



**NON-METALLIC
 90 DEGREE ELBOW**

- MA-LC20D** 1/2" SCREW ON (10/BOX)
MA-4LC20D 1/2" SCREW ON (4/PKG)
MA-LC20E 3/4" SCREW ON (10/BOX)
MA-4LC20E 3/4" SCREW ON (4/PKG)



1 PIECE

**HEAT PUMP
 STANDS**

- MA-HP3** 3" 1 PIECE
MA-HP6 6" 1 PIECE



2 PIECES

- MA-HP3-2P** 3" 2 PIECE
MA-HP6-2P 6" 2 PIECE



4" EXTENSION

- MA-EXT4**
 4" EXTENSION FOR 2 PIECES HEAT
 PUMP STANDS

- MA-E2PL-1** 1/2" WIDE 100/PKG
2-NAIL STRAPS FITS 2 - 3 #12 NM
CABLE, OR 2 #12 UF CABLE
- MA-E3PL-1** 3/4" WIDE 100/PKG
2-NAIL STRAPS FITS 2 #8 NM & U
CABLE, OR 3 #12 UF CABLE
- MA-E2PL25** 1/2" WIDE 25/PKG
2-NAIL STRAPS FITS 2 - 3 #12 NM
CABLE, OR 2 #12 UF CABLE
- MA-E3PL25** 3/4" WIDE 25/PKG
2-NAIL STRAPS FITS 2 #8 NM & U
CABLE, OR 3 #12 UF CABLE

CABLE STRAPS



2 NAIL STRAP

FLEXIBLE STEEL CONDUIT

TYPE ULC LIQUID TIGHT- UL APPROVED ONLY

- MA-10050** 1/2" X 100'
MA-10075 3/4" X 100'
MA-10010 1" X 100'



LIQUID TIGHT

NON-METALLIC CONDUIT
U.L. AND CSA APPROVED

- MA-15005** 1/2" X 100'
MA-15007 3/4" X 100'
MA-15008 1" X 100'



UV (SUNLIGHT) RESISTANT

FITTINGS FOR BX-FLEXIBLE METAL CONDUIT

STEEL & ALUMINUM FLEX, AC & MC CABLE

- MA-E42-1** 1/2" STRAIGHT SQUEEZE CONN.(TYPE A) 25/PKG.
MA-E42-2 3/4" STRAIGHT SQUEEZE CONN.(TYPE A) 25/PKG.
MA-E42-3 1" STRAIGHT SQUEEZE CONN.(TYPE A) 10/PKG.
MA-E42-4 1-1/4" STRAIGHT SQUEEZE CONN.(TYPE A) 10/PKG.
MA-E42-5 1-1/2" STRAIGHT SQUEEZE CONN.(TYPE A) 5/PKG.
MA-E110 3/8" 90 DEGREE SET SCREW CONN.(TYPE B) 50/PKG.
MA-E110-1 1/2" 90 DEGREE SET SCREW CONN.(TYPE B) 25/PKG.
MA-E110-2 3/4" 90 DEGREE SET SCREW CONN.(TYPE B) 15/PKG.
MA-E110-3 1" 90 DEGREE SET SCREW CONN.(TYPE B) 10/PKG.
MA-E110-4 1-1/4" 90 DEGREE SET SCREW CONN.(TYPE B) 5/PKG.
MA-E110-5 1-1/2" 90 DEGREE SET SCREW CONN.(TYPE B) 1/PKG.
MA-E57 3/8" COMBINATION CONNECTOR (TYPE D) 100/PKG.
MA-4E421 1/2" STRAIGHT SQUEEZE CONN. (TYPE A) 4/PKG.
MA-4E422 3/4" STRAIGHT SQUEEZE CONN. (TYPE B) 4/PKG.
MA-4E110 3/8" 90 DEGREE SET SCREW CONN.(TYPE B) 4/PKG.
MA-4E1101 1/2" 90 DEGREE SET SCREW CONN.(TYPE B) 4/PKG.
MA-4E1102 3/4" 90 DEGREE SET SCREW CONN.(TYPE B) 4/PKG.
MA-4E57 3/8" COMBINATION CONNECTOR (TYPE D) 4/PKG.

NM CABLE

- MA-E104A** 3/4" CABLE CONNECTOR (TYPE E) 50/PKG.
MA-E105 1" CABLE CONNECTOR (TYPE E) 25/PKG.
MA-E106 1-1/4" CABLE CONNECTOR (TYPE E) 10/PKG.
MA-E107 1-1/2" CABLE CONNECTOR (TYPE E) 10/PKG.
MA-E51 3/8" ROMEX CONNECTOR (TYPE E) 100/PKG
MA-4E104A 3/4" CABLE CONNECTOR (TYPE E) 4/PKG.
MA-4E51 3/8" ROMEX CONNECTOR (TYPE E) 4/PKG

FLEX, MC & AC CABLE

- MA-E58** 3/8" SET SCREW CONNECTOR (TYPE F) 100/PKG.
MA-E48 1/2" SET SCREW CONNECTOR (TYPE F) 25/PKG.
MA-4E58 3/8" SET SCREW CONNECTOR (TYPE F) 4/PKG.
MA-4E48 1/2" SET SCREW CONNECTOR (TYPE F) 4/PKG.

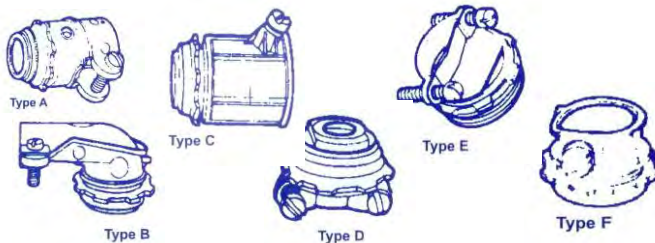

FLEXIBLE STEEL CONDUIT

TYPE EFC-NON-UL LIQUID TIGHT

- MA-20050** 1/2" X 100'
MA-20075 3/4" X 100'
MA-20010 1" X 100'



MEETS JIC REQUIREMENTS. DOES NOT
CONTAIN CONTINUOUS COPPER GROUND.

ALUMINUM (GREENFIELD)

- MA-30038** 3/8" X 100'
MA-30050 1/2" X 100'
MA-30075 3/4" X 100'

FLEXIBLE CONDUIT

ALUMINUM AND STEEL

STEEL (GREENFIELD)

- MA-40038** 3/8" X 100'
MA-40050 1/2" X 100'
MA-40075 3/4" X 100'



TYPE MC ALUMINUM CLAD CABLE

WITH INSULATED GREEN GROUND WIRE

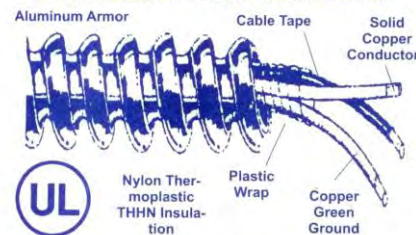

- MA-MC42C**
14/2 - 100'
MA-MC22C
12/2 - 100'
MA-MC43C
14/3 - 100'
MA-MC23C
12/3 - 100'

MA-LINE TYPE MC CABLE IS USED IN COMMERCIAL, INDUSTRIAL AND UTILITY APPLICATIONS WHERE SPACE AND EASE OF INSTALLATION IS CRITICAL. MC CABLE HANDLES POWER SERVICE, LIGHTING, CONTROL AND SIGNAL CIRCUITS. MAY BE USED IN CABLE TRAYS, APPROVED RACEWAYS, OR AS AN OPEN RUN OF CABLE. MADE OF ALUMINUM INTERLOCKED ARMOR, SOLID COPPER CONDUCTORS.

600 VOLTS - THHN CONDUCTORS WITH GREEN INSULATED GROUND. MEETS U.L. 1569.

ANTI-SHORT BUSHINGS

FOR FLEX - AC - MC CABLE



- MA-E0PL** FITS CABLE SIZE: 14/2, 14/3, 12/2
TRADE SIZE: 5/16" 100/PKG
MA-E1PL FITS CABLE SIZE: 14/4, 12/3, 6/1, 4/1
TRADE SIZE: 3/8" 100/PKG
MA-E2PL FITS CABLE SIZE: 12/4, 10/2, 10/3, 2/1
TRADE SIZE: 7/16" 50/PKG
MA-E3PL FITS CABLE SIZE: 10/4, 8/2, 8/3, 1/1
TRADE SIZE: 1/2" 50/PKG
MA-E4PL FITS CABLE SIZE: 8/4, 6/2, 6/3, 6/4, 4/2, 4/3
TRADE SIZE: 3/4" 10/PKG

FITTINGS FOR RIGID CONDUIT

- MA-E376** 1/2" OFFSET NIPPLES (TYPE A) 20/PKG.
- MA-E377** 3/4" OFFSET NIPPLES (TYPE A) 10/PKG.
- MA-E378** 1" OFFSET NIPPLES (TYPE A) 10/PKG.
- MA-E379** 1-1/4" OFFSET NIPPLES (TYPE A) 10/PKG.
- MA-E380** 1-1/2" OFFSET NIPPLES (TYPE A) 10/PKG.
- MA-E96-1CG** 1/2" LB TYPE THREADED OVAL CONDUIT BODY WITH COVER AND GASKET (TYPE B) 10/PKG.
- MA-E96-2CG** 3/4" LB TYPE THREADED OVAL CONDUIT BODY WITH COVER AND GASKET (TYPE B) 10/PKG.
- MA-E96-4CG** 1-1/4" LB TYPE THREADED OVAL CONDUIT BODY WITH COVER AND GASKET (TYPE B) 2/PKG.
- MA-E96-5CG** 1-1/2" LB TYPE THREADED OVAL CONDUIT BODY WITH COVER AND GASKET (TYPE B) 2/PKG.
- MA-E900** 1/2" SLB SERVICE ENTRANCE ELBOW (TYPE C) 10/PKG.
- MA-E901** 3/4" SLB SERVICE ENTRANCE ELBOW (TYPE C) 10/PKG.
- MA-E902** 1" SLB SERVICE ENTRANCE ELBOW (TYPE C) 5/PKG.
- MA-E903** 1-1/4" SLB SERVICE ENTRANCE ELBOW (TYPE C) 5/PKG.
- MA-E904** 1-1/2" SLB SERVICE ENTRANCE ELBOW (TYPE C) 2/PKG.
- MA-E59** 1/2" CONDUIT LOCKNUTS FULLY REVERSIBLE (TYPE D) 200/PKG.
- MA-E80** 3/4" CONDUIT LOCKNUTS FULLY REVERSIBLE (TYPE D) 100/PKG.
- MA-E81** 1" CONDUIT LOCKNUTS FULLY REVERSIBLE (TYPE D) 100/PKG.
- MA-E82** 1-1/4" CONDUIT LOCKNUTS FULLY REVERSIBLE (TYPE D) 50/PKG.
- MA-E83** 1-1/2" CONDUIT LOCKNUTS FULLY REVERSIBLE (TYPE D) 50/PKG.
- MA-4E59** 1/2" CONDUIT LOCKNUTS FULLY REVERSIBLE (TYPE D) 4/PKG.
- MA-25E59** 1/2" CONDUIT LOCKNUTS FULLY REVERSIBLE (TYPE D) 25/PKG.
- MA-25E80** 3/4" CONDUIT LOCKNUTS FULLY REVERSIBLE (TYPE D) 25/PKG.
- MA-E52PL** 1/2" PLASTIC INSULATED BUSHING (TYPE E) 100/PKG.
- MA-E60PL** 3/4" PLASTIC INSULATED BUSHING (TYPE E) 100/PKG.
- MA-E61PL** 1" PLASTIC INSULATED BUSHING (TYPE E) 50/PKG.
- MA-E65PL** 1-1/4" PLASTIC INSULATED BUSHING (TYPE E) 25/PKG.
- MA-E69PL** 1-1/2" PLASTIC INSULATED BUSHING (TYPE E) 25/PKG.
- MA-E298-21** 3/4" X 1/2" REDUCING WASHER (TYPE F) 250/PKG.
- MA-E298-31** 1" X 1/2" REDUCING WASHER (TYPE F) 100/PKG.
- MA-E298-32** 1" X 3/4" REDUCING WASHER (TYPE F) 100/PKG.
- MA-E298-41** 1-1/4" X 1/2" REDUCING WASHER (TYPE F) 200/PKG.
- MA-E298-42** 1-1/4" X 3/4" REDUCING WASHER (TYPE F) 200/PKG.
- MA-E298-43** 1-1/4" X 1" REDUCING WASHER (TYPE F) 200/PKG.
- MA-E298-51** 1-1/2" X 1/2" REDUCING WASHER (TYPE F) 100/PKG.
- MA-E298-52** 1-1/2" X 3/4" REDUCING WASHER (TYPE F) 100/PKG.
- MA-E298-53** 1-1/2" X 1" REDUCING WASHER (TYPE F) 100/PKG.
- MA-E298-54** 1-1/2" X 1-1/4" REDUCING WASHER (TYPE F) 100/PKG.
- MA-25E29821** 3/4" X 1/2" REDUCING WASHER (TYPE F) 25/PKG.
- MA-25E29831** 1" X 1/2" REDUCING WASHER (TYPE F) 25/PKG.
- MA-25E29832** 1" X 3/4" REDUCING WASHER (TYPE F) 25/PKG.



FITTINGS FOR THINWALL CONDUIT (EMT)

COMPRESSION TYPE – RAIN TIGHT

- MA-E21** 1/2" CONNECTOR (TYPE A) 50/PKG.
- MA-E23** 3/4" CONNECTOR (TYPE A) 25/PKG.
- MA-E25** 1" CONNECTOR (TYPE A) 15/PKG.
- MA-E27** 1-1/4" CONNECTOR (TYPE A) 5/PKG.
- MA-E29** 1-1/2" CONNECTOR (TYPE A) 10/PKG.
- MA-E22** 1/2" CONNECTOR (TYPE B) 50/PKG.
- MA-E24** 3/4" CONNECTOR (TYPE B) 25/PKG.
- MA-E26** 1" CONNECTOR (TYPE B) 15/PKG.
- MA-E28** 1-1/4" CONNECTOR (TYPE B) 10/PKG.
- MA-E30** 1-1/2" CONNECTOR (TYPE B) 10/PKG.
- MA-4E21** 1/2" CONNECTOR (TYPE A) 4/PKG.
- MA-4E23** 3/4" CONNECTOR (TYPE A) 4/PKG.
- MA-4E22** 1/2" CONNECTOR (TYPE B) 4/PKG.
- MA-4E24** 3/4" CONNECTOR (TYPE B) 4/PKG.

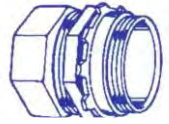

TYPE A



TYPE B

SET SCREW TYPE – CONCRETE TIGHT

- MA-E121** 1/2" CONNECTOR (TYPE C) 50/PKG.
- MA-E123** 3/4" CONNECTOR (TYPE C) 25/PKG.
- MA-E125** 1" CONNECTOR (TYPE C) 20/PKG.
- MA-E127** 1-1/4" CONNECTOR (TYPE C) 5/PKG.
- MA-E129** 1-1/2" CONNECTOR (TYPE C) 10/PKG.
- MA-E122** 1/2" COUPLING (TYPE D) 50/PKG.
- MA-E124** 3/4" COUPLING (TYPE D) 25/PKG.
- MA-E126** 1" COUPLING (TYPE D) 15/PKG.
- MA-E128** 1-1/4" COUPLING (TYPE D) 20/PKG.
- MA-E130** 1-1/2" COUPLING (TYPE D) 10/PKG.
- MA-4E121** 1/2" CONNECTOR (TYPE C) 4/PKG.
- MA-4E123** 3/4" CONNECTOR (TYPE C) 4/PKG.
- MA-4E122** 1/2" COUPLING (TYPE D) 4/PKG.
- MA-4E124** 3/4" COUPLING (TYPE D) 4/PKG.



TYPE C



TYPE D

CONNECTORS, ELBOWS & STRAPS

- MA-E2390-2** 3/4" 90 DEG. EMT CONNECTOR (TYPE E) 20/PKG
- MA-E37-1** 1/2" OFFSET CONNECTOR EMT TO BOX (TYPE F) 20/PKG
- MA-E37-2** 3/4" OFFSET CONNECTOR EMT TO BOX (TYPE F) 20/PKG
- MA-E37-3** 1" OFFSET CONNECTOR EMT TO BOX (TYPE F) 20/PKG
- MA-E144-1** 1/2" EMT PULL ELBOWS (TYPE G) 10/PKG
- MA-E144-2** 3/4" EMT PULL ELBOWS (TYPE G) 5/PKG
- MA-2E1441** 1/2" EMT PULL ELBOWS (TYPE G) 2/PKG
- MA-2E1442** 3/4" EMT PULL ELBOWS (TYPE G) 2/PKG
- MA-E55** 1/2" STEEL DRIVE STRAPS (TYPE H) 100/PKG
- MA-E7S** 3/4" STEEL DRIVE STRAPS (TYPE H) 100/PKG
- MA-E10S** 1" STEEL DRIVE STRAPS (TYPE H) 100/PKG



TYPE F



TYPE H



TYPE E



TYPE G



- D109** (2/PKG) INLET: 1/4" OUTLET: 1/4"
3/4" X 8-1/2" NON-DIRECTIONAL DRIER
- D110** (2/PKG) INLET: 1/4" OUTLET: 1/4"
3/4" X 8-3/4" DIRECTIONAL FUSED ENDS DRIER
- D111** (2/PKG) INLET: 1/4" OUTLET: 1/4" OR CAP
1" X 8-3/4" DIRECTIONAL CHARGING DRIER
- D112** (2/PKG) INLET: 5/16" OUTLET: 5/16"
1" X 10-3/4" DIRECTIONAL STEP DOWN DRIER
- D113** (2/PKG) INLET: (2)1/4" OUTLET: 1/4"
1" X 8-3/4" DIRECTIONAL DOUBLE INLET DRIER
- D114** (2/PKG) INLET: MULTIPLE OUTLET: 1/4"
1" X 9" DIRECTIONAL FUSED ENDS DRIER



COPPER SPUN DRIERS
DRIERS CONTAIN
XH-9 DESICCANT
PRICE PER PACKAGE
2 PER PACKAGE

- D115** (2/PKG)
INLET: 1/4"ID, 1/4"OD & 1/4" FLARE OUTLET: 1/4"
3/4" X 9" DIRECTIONAL CHARGING DRIER

LIQUID LINE FILTER DRIER
DCH SERIES
(SOLID CORE TYPE)

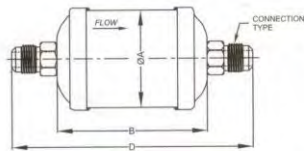

DCH DRIER WITH SAE CONNECTION DIMENSIONS DRAWING 1

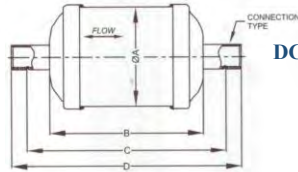

DCH BI-FLOW DRIER WITH ODF CONNECTION DIMENSIONS DRAWING 2

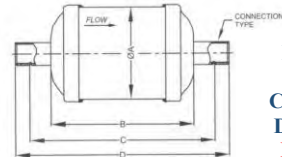

DCH DRIER WITH ODF CONNECTION DIMENSIONS DRAWING 3

INTERNAL ASSEMBLY
CORE TYPE
ODS TYPE CONNECTION
COPPER
MAXIMUM WORKING
PRESSURE
45 BAR (653 PSIG)
SAE TYPE CONNECTION
NICKEL PLATED
STEEL

DCH052F
1/4" **SAE** LIQUID LINE FILTER DRIER
1/4" **SAE** CONNECTION,
4.88" OVERALL LENGTH
DRAWING 1

DCHBF083S
3/8" **ODF** LIQUID LINE FILTER DRIER
BI-FLOW, 3/8" **ODF** CONNECTION,
5.78" OVERALL LENGTH

DCHBF163S
3/8" **ODF** LIQUID LINE FILTER DRIER
BI-FLOW, 3/8" **ODF** CONNECTION,
6.57" OVERALL LENGTH
DRAWING 2

DCH032S
1/4" **ODF** LIQUID LINE FILTER DRIER
1/4" **ODF** CONNECTION,
4.61" OVERALL LENGTH

DCH033S
3/8" **ODF** LIQUID LINE FILTER DRIER
3/8" **ODF** CONNECTION,
4.61" OVERALL LENGTH
DRAWING 3

DCH052S
1/4" **ODF** LIQUID LINE FILTER DRIER
1/4" **ODF** CONNECTION,
5.04" OVERALL LENGTH

DCH053S
3/8" **ODF** LIQUID LINE FILTER DRIER
3/8" **ODF** CONNECTION,
5.04" OVERALL LENGTH

DCH082S
1/4" **ODF** LIQUID LINE FILTER DRIER
1/4" **ODF** CONNECTION,
5.86" OVERALL LENGTH

DCH083S
3/8" **ODF** LIQUID LINE FILTER DRIER
3/8" **ODF** CONNECTION,
5.86" OVERALL LENGTH

DCH163S
3/8" **ODF** LIQUID LINE FILTER DRIER
3/8" **ODF** CONNECTION,
6.77" OVERALL LENGTH

DCH164S
1/2" **ODF** LIQUID LINE FILTER DRIER
1/2" **ODF** CONNECTION,
6.77" OVERALL LENGTH
DRAWING 3

DCH165S
5/8" **ODF** LIQUID LINE FILTER DRIER
35/8" **ODF** CONNECTION,
6.77" OVERALL LENGTH

DCH303S
3/8" **ODF** LIQUID LINE FILTER DRIER
3/8" **ODF** CONNECTION,
9.45" OVERALL LENGTH

DCH304S
1/2" **ODF** LIQUID LINE FILTER DRIER
1/2" **ODF** CONNECTION,
9.45" OVERALL LENGTH

DCH305S
5/8" **ODF** LIQUID LINE FILTER DRIER
5/8" **ODF** CONNECTION,
9.45" OVERALL LENGTH

DCH306S
3/4" **ODF** LIQUID LINE FILTER DRIER
3/4" **ODF** CONNECTION,
9.45" OVERALL LENGTH

DCH307S
7/8" **ODF** LIQUID LINE FILTER DRIER
7/8" **ODF** CONNECTION,
10.39" OVERALL LENGTH

DCH309S
1-1/8" **ODF** LIQUID LINE FILTER DRIER
1-1/8" **ODF** CONNECTION,
10.39" OVERALL LENGTH
DRAWING 3



VALVE CORE TOOL

AF2199P (2/PKG.)

PLASTIC STORAGE
 INCLUDES 10 CORES
 IN EACH TOOL
 (20 CORES/PKG.)

PRICE PER PACKAGE

VALVE CORE TOOL

AF2200-M (1/PKG.)

METAL STORAGE
 INCLUDES 6 CORES

PRICE PER PACKAGE



**COPPER TUBE EXTENSIONS
 WITH 1/4" FITTING**



5/PKG-PRICE/PKG

- AF1000** 1/8"OD
- AF1100** 3/16"OD
- AF1200** 1/4"OD
- AF1300** 5/16"OD
- AF1400** 3/8"OD

50/PKG-PRICE/PKG

- AF1000-50** 1/8"OD
- AF1100-50** 3/16"OD
- AF1200-50** 1/4"OD
- AF1300-50** 5/16"OD
- AF1400-50** 3/8"OD

PRICE PER PACKAGE

**CAP AND REPLACEMENT
 VALVE CORES**



AF2000 – AF2000BX
 PRICE PER PACKAGE

**1/4"SAE GASKET
 SEAL CAP
 WITH
 CORE REMOVER**

- AF2000** (10/PKG)
- AF2000BX** (100/PKG)



AF2100
 AF2100-25
 AF2100-100
 PRICE PER PACKAGE

1/4" VALVE CORE

COPPER TUBE EXTENSIONS

WITH 5/16" FITTING
 5/16" MALE FLARE –
 COPPER EXTENTION 2" LONG



- AF11516**
 3/16"ODS X 1/4"ODF (3/PKG)
- AF12516**
 1/4"ODS X 5/16"ODF (3/PKG)
- AF13516**
 5/16"ODS X 3/8"ODF (3/PKG)

PRICE PER PACKAGE

**COPPER TUBE EXTENSIONS
 WITH MULTI-STEPS**



- AF1500** (3/PKG)
- AF1500-50** (50/PKG)
 1/8"OD, 3/16", 1/4" AND 5/16"
 ODF MULTI STEPS
- AF1600** (3/PKG)
- AF1600-50** (50/PKG)
 3/16"OD X 1/8"ID, 1/4" AND 3/8"
 ODF MULTI STEPS

PRICE PER PACKAGE

**MULTI-STEP
 BRASS BODY**



- AF1900** (3/PKG)
- AF1900-50** (50/PKG)
 1/8"OD X 3/16", 1/4",
 OR 5/16"ODF STEPS

PRICE PER PACKAGE



MA-SVOM18
 18MM/.75"
 SOLENOID VALVE
 OPERATING MAGNET

**COPPER SOLDER
 TEES
 WITH 1/4"
 MALE FLARE**
 PRICE PER PACKAGE



- | | |
|---|-------------------------------------|
| AF3134 (3/PKG)
1/4" ODS X 5/16" ODF | AF3140 (1/PKG)
5/8" ODS |
| AF3135 (3/PKG)
5/16" ODS X 3/8" ODF | AF3142 (1/PKG)
3/4" ODS |
| AF3136 (3/PKG)
3/8" ODS X 1/2" ODF | AF3144 (1/PKG)
7/8" ODS |
| AF3138 (3/PKG)
1/2" ODS | AF3148 (1/PKG)
1-1/8" ODS |



**SWIVEL
 FLARE
 CONNECTION**

- AF1700** (3/PKG) **AF1700-50** (50/PKG)
 1/4" FE SAE SWIVEL NUT ON BRANCH
AF1800 (3/PKG) **AF1800-50** (50/PKG)
 1/4" FE SAE SWIVEL NUT ON RUN

**5/16" ADAPTER FOR
 R-410 SYSTEMS & MINI SPLITS**
MA-19173



**REFRIGERANT RETENTION
 CONTROL VALVE**



- MA-33002**
 1/4" FLF X 1/4" FLM
MA-33005
 5/16" FLF X 5/16" FLM
MA-33008
 5/16" FLF X 1/4" FLM

**4 IN 1 VACUUM/CHARGE
 VALVE AND CORE TOOL**



- MA-18975**
 1/4" WITH SIDE PORT
MA-18985
 5/16" WITH SIDE PORT

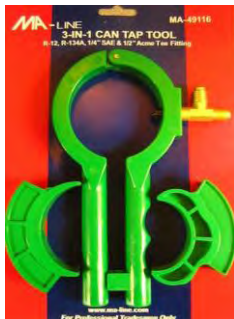





MA-49116
 3 IN 1
 12 OZ. CAN TAP

**ADJUSTABLE
 LINE TAP VALVE**

- MA-V1**
 1/4", 5/16", & 3/8" OD
MA-V2
 1/2" & 5/8" OD



PART #	DESCRIPTION	PKG.	MALLEABLE BLACK IRON PIPE FITTINGS	PART #	DESCRIPTION	PKG.
MA-12U	1/2" UNION	50	 UNION  REDUCING COUPLING  COUPLING  45 ELBOW  90 ELBOW  90 STREET ELBOW  TEE  CAP  REDUCING TEE  PLUG  BUSHING	MA-12T	1/2" TEE	60
MA-34U	3/4" UNION	35		MA-34T	3/4" TEE	35
MA-1U	1" UNION	20		MA-1T	1" TEE	20
MA-12CPLG	1/2" COUPLING	120		MA-341212T	3/4" X 1/2" X 1/2" TEE	50
MA-34CPLG	3/4" COUPLING	75		MA-343412T	3/4" X 3/4" X 1/2" TEE	40
MA-1CPLG	1" COUPLING	50		MA-1238BG	1/2" X 3/8" HEX BUSHING	300
MA-3412CPLG	3/4" X 1/2" RED. COUPLING	90		MA-3412BG	3/4" X 1/2" HEX BUSHING	150
MA-112CPLG	1" X 1/2" RED. COUPLING	30		MA-112BG	1" X 1/2" HEX BUSHING	100
MA-134CPLG	1" X 3/4" RED. COUPLING	50		MA-134BG	1" X 3/4" HEX BUSHING	100
MA-1290EL	1/2" 90 DEGREE ELBOW	100		MA-12CAP	1/2" CAP	150
MA-3490EL	3/4" 90 DEGREE ELBOW	35		MA-34CAP	3/4" CAP	80
MA-190EL	1" 90 DEGREE ELBOW	30		MA-1CAP	1" CAP	50
MA-1245EL	1/2" 45 DEGREE ELBOW	100		MA-12PLG	1/2" PLUG	300
MA-3445EL	3/4" 45 DEGREE ELBOW	60	MA-34PLG	3/4" PLUG	180	
MA-145EL	1" 45 DEGREE ELBOW	30	MA-1PLG	1" PLUG	120	
MA-1290STEL	1/2" 90 DEG. STR. ELBOW	90	SPECIFICATIONS: MATERIAL: ASTM A-197 DIMENSIONS: ANSI B16.3 & ANSI B16.14 THREADS: ANSI B1.20.1			
MA-3490STEL	3/4" 90 DEG. STR. ELBOW	35				
MA-190STEL	1" 90 DEG. STR. ELBOW	30				



**PLASTIC
NIPPLE TRAYS
INCLUDES DRAIN
HOLES**

- MA-T1005 1/2" NIPPLE TRAY
- MA-T1007 3/4" NIPPLE TRAY
- MA-T1010 1" NIPPLE TRAY
- MA-T1057 1/2" & 3/4" NIPPLE TRAY

**CARDBOARD NIPPLE TRAYS
WITH ASSORTED NIPPLES**

- MA-1266T 1/2" (66 PCS)
6EA. OF CLOSE TO 6"
- MA-3466T 3/4" (66 PCS)
6EA. OF CLOSE TO 6"
- MA-0160T 1" (60 PCS)
6EA. OF CLOSE TO 6"



**WELDED STEEL
BLACK IRON PIPE NIPPLES**

PIPE NIPPLES MEET THE ASTM A733
SPECIFICATIONS

PART #	DESCRIPTION	PKG.	PART #	DESCRIPTION	PKG.	PART #	DESCRIPTION	PKG.
MA-BN12CL	1/2" X CL-1-1/8"	25	MA-BN34CL	3/4" X CL-1-3/8"	25	MA-BN1CL	1" X CL-1-1/2"	25
MA-BN12112	1/2" X 1-1/2"	25	MA-BN34112	3/4" X 1-1/2"	25	MA-BN12	1" X 2"	25
MA-BN122	1/2" X 2"	25	MA-BN342	3/4" X 2"	25	MA-BN1212	1" X 2-1/2"	25
MA-BN12212	1/2" X 2-1/2"	25	MA-BN34212	3/4" X 2-1/2"	25	MA-BN13	1" X 3"	25
MA-BN123	1/2" X 3"	25	MA-BN343	3/4" X 3"	25	MA-BN1312	1" X 3-1/2"	25
MA-BN12312	1/2" X 3-1/2"	25	MA-BN34312	3/4" X 3-1/2"	25	MA-BN14	1" X 4"	25
MA-BN124	1/2" X 4"	25	MA-BN344	3/4" X 4"	25	MA-BN1412	1" X 4-1/2"	25
MA-BN12412	1/2" X 4-1/2"	25	MA-BN34412	3/4" X 4-1/2"	25	MA-BN15	1" X 5"	25
MA-BN125	1/2" X 5"	25	MA-BN345	3/4" X 5"	25	MA-BN1512	1" X 5-1/2"	25
MA-BN12512	1/2" X 5-1/2"	25	MA-BN34512	3/4" X 5-1/2"	25	MA-BN16	1" X 6"	25
MA-BN126	1/2" X 6"	25	MA-BN346	3/4" X 6"	25	MA-BP112	1" X 12"	1
MA-BP1212	1/2" X 12"	1	MA-BP3412	3/4" X 12"	1	MA-BP118	1" X 18"	1
MA-BP1218	1/2" X 18"	1	MA-BP3418	3/4" X 18"	1	MA-BP124	1" X 24"	1
MA-BP1224	1/2" X 24"	1	MA-BP3424	3/4" X 24"	1	MA-BP130	1" X 30"	1
MA-BP1230	1/2" X 30"	1	MA-BP3430	3/4" X 30"	1	MA-BP136	1" X 36"	1
MA-BP1236	1/2" X 36"	1	MA-BP3436	3/4" X 36"	1	MA-BP148	1" X 48"	1
MA-BP1248	1/2" X 48"	1	MA-BP3448	3/4" X 48"	1	MA-BP160	1" X 60"	1
MA-BP1260	1/2" X 60"	1	MA-BP3460	3/4" X 60"	1			



Type "A"



Type "B"



Type "C"



Type "D"



Type "E"



Type "F"



Type "G"



Type "H"



Type "I"



Type "J"



Type "K"



Type "L"



Type "M"



Type "N"

SCHEDULE 40 PVC FITTINGS

PART #	DESCRIPTION	PKG.	TYPE	PART #	DESCRIPTION	PKG.	TYPE
MA-30105	COUPLING 1/2" SLIP X SLIP	100	A	MA-450007	PLUG 3/4" MPT	50	
MA-30107	COUPLING 3/4" SLIP X SLIP	50	A	MA-30275	REDUCING BUSHING 3/4" SLIP X 1/2" SLIP	100	J
MA-30110	COUPLING 1" SLIP X SLIP	50	A	MA-437131	REDUCING BUSHING 1" SLIP X 3/4" SLIP	100	J
MA-30605	ELBOW 45° 1/2" SLIP X SLIP	50	B	MA-436074	REDUCING MPT ADAPTOR 3/4" SLIP X 1/2" MPT	100	H
MA-30607	ELBOW 45° 3/4" SLIP X SLIP	50	B	MA-32905	STREET ELBOW 90° 1/2" SLIP	50	M
MA-30610	ELBOW 45° 1" SLIP X SLIP	50	B	MA-32907	STREET ELBOW 90° 3/4" SLIP	50	M
MA-30705	ELBOW 90° 1/2" SLIP X SLIP	50	C	MA-409010	STREET ELBOW 90° 1" SLIP	50	M
MA-30707	ELBOW 90° 3/4" SLIP X SLIP	50	C	MA-33905	ELBOW 90° 1/2" SLIP X FPT	50	K
MA-30710	ELBOW 90° 1" SLIP X SLIP	50	C	MA-33907	ELBOW 90° 3/4" SLIP X FPT	50	K
MA-31318	1/2" CLEAN OUT TEE	1	L	MA-33910	ELBOW 90° 1" SLIP X FPT	50	K
MA-31348	3/4" CLEAN OUT TEE	1	L	MA-401020	TEE 2" SLIP X SLIP X SLIP	25	D
MA-31405	TEE 1/2" SLIP X SLIP X SLIP	50	D	MA-407074	ELBOW 90 3/4" FPT X 1/2"SLIP	50	K
MA-31407	TEE 3/4" SLIP X SLIP X SLIP	50	D	MA-410005	STREET ELBOW 90° 1/2" MPT X 1/2"SLIP	50	M
MA-31410	TEE 1" SLIP X SLIP X SLIP	50	D	MA-410007	STREET ELBOW 90° 3/4" MPT X 3/4"SLIP	50	M
MA-30305	ADAPTOR 1/2" SLIP X FPT	100	E	MA-410010	STREET ELBOW 90° 1" MPT X 1"SLIP	50	M
MA-30307	ADAPTOR 3/4" SLIP X FPT	50	E	MA-410101	STREET ELBOW 90° 3/4" MPT X 1/2"SLIP	50	M
MA-30311	ADAPTOR 1" SLIP X FPT	50	E	MA-457005	UNION 1/2" SLIP X SLIP	10	N
MA-30357	REDUCING FPT ADAPTOR 1/2" SLIP X 3/4"FPT	50	F	MA-457007	UNION 3/4" SLIP X SLIP	10	N
MA-30405	ADAPTOR 1/2" SLIP X MPT	100	G	MA-457010	UNION 1" SLIP X SLIP	10	N
MA-30407	ADAPTOR 3/4" SLIP X MPT	50	G	MA-457012	UNION 1-1/4" SLIP X SLIP	5	N
MA-30410	ADAPTOR 1" SLIP X MPT	50	G	MA-457015	UNION 1-1/2" SLIP X SLIP	5	N
MA-30457	REDUCING MPT ADAPTOR 1/2" SLIP X 3/4"MPT	50	H	MA-457020	UNION 2" SLIP X SLIP	2	N
MA-30155	CAP 1/2" SLIP	100	I				
MA-30157	CAP 3/4" SLIP	50	I				
MA-30158	CAP 1" SLIP	50	I				
MA-448007	CAP 3/4" FPT	100					

PART #	DESCRIPTION	PKG.	TYPE	SCHEDULE 40 PVC-DWV FITTINGS	PART #	DESCRIPTION	PKG.	TYPE
MA-70115	COUPLING 1-1/2"	100	A	<p>Type "A"</p> <p>Type "B"</p> <p>Type "C"</p> <p>Type "D"</p> <p>Type "E"</p> <p>Type "F"</p> <p>Type "G"</p> <p>Type "H"</p> <p>Type "I"</p>	MA-417025	45° ELBOW 2-1/2" SCH 40	10	H
MA-70120	COUPLING 2"	100	A		MA-70630	45° ELBOW 3"	20	H
MA-429025	COUPLING 2-1/2" SCH 40	10	A		MA-D321040	45° ELBOW 4"	100	H
MA-70130	COUPLING 3"	60	A		MA-73815	90° LONG SWEEP ELBOW 1-1/2"	50	F
MA-D100040	COUPLING 4"	25	A		MA-73820	90° LONG SWEEP ELBOW 2"	25	F
MA-70121	RED. COUPLING 2" X 1-1/2"	25	B		MA-73830	90° LONG SWEEP ELBOW 3"	10	F
MA-70132	RED. COUPLING 3" X 2"	20	B		MA-D304040	90° LONG SWEEP ELBOW 4"	5	F
MA-D102420	RED. COUPLING 4" X 2"	10	B		MA-71115	TEE 1-1/2"	100	G
MA-D102422	RED. COUPLING 4" X 3"	10	B		MA-71120	TEE 2"	35	G
MA-70116	REPAIR COUPLING 1-1/2"	25	C		MA-401025	TEE SCH. 40 2-1/2"	10	G
MA-70122	REPAIR COUPLING 2"	25	C		MA-71130	TEE 3"	30	G
MA-70133	REPAIR COUPLING 3"	10	C		MA-D400040	TEE 4"	5	G
MA-D130040	REPAIR COUPLING 4"	5	C		MA-70221	BUSHING SCH. 40 2" X 1-1/2"	50	I
MA-70151	CAP SCH. 40 1-1/2"	25	D		MA-437292	BUSHING SCH. 40 2-1/2" X 2"	10	I
MA-70152	CAP SCH. 40 2"	25	D		MA-70231	BUSHING SCH. 40 3" X 1-1/2"	30	I
MA-447025	CAP SCH. 40 2-1/2"	10	D		MA-70232	BUSHING 3" X 2"	30	I
MA-70153	CAP SCH. 40 3"	10	D		MA-437339	BUSHING SCH. 40 3" X 2-1/2"	10	I
MA-447040	CAP SCH. 40 4"	5	D		MA-D309015	LONG SWP. STR. ELB. 1-1/2"	10	
MA-72815	90° ELBOW 1-1/2"	100	E	MA-D309020	LONG SWP. STR. ELB. 2"	25		
MA-72820	90° ELBOW 2"	50	E	MA-D309030	LONG SWP. STR. ELB. 3"	20		
MA-406025	90° ELBOW SCH 40 2-1/2"	10	E	MA-D323015	45° STR. ELB. 1-1/2"	100		
MA-72830	90° ELBOW 3"	25	E	MA-D323020	45° STR. ELB. 2"	50		
MA-D300040	90° ELBOW 3"	10	E	MA-D323030	45° STR. ELB. 3"	20		
MA-70615	45° ELBOW 1-1/2"	100	H	MA-207013	NIPPLE TBE SCH. 80 3/4" X CL	50		
MA-70620	45° ELBOW 2"	50	H	MA-207030	NIPPLE TBE SCH. 80 3/4" X 3"	50		

NYLON FITTINGS

ASSORTED NYLON FITTING RACK **MA-105NYFIT**



PART #	DESCRIPTION	QTY/PKG	QUANTITY
MA-12032	CONNECTOR 3/8" BARB	5	6
MA-12033	CONNECTOR 1/2" BARB	4	4
MA-12034	CONNECTOR 5/8" BARB	4	6
MA-12035	CONNECTOR 3/4" BARB	3	4
MA-22006	ADAPTER 3/8"BARB X 1/2"MPT	8	4
MA-22010	ADAPTER 1/2"BARB X 3/4"MPT	4	6
MA-22012	ADAPTER 5/8"BARB X 3/4"MPT	4	6
MA-22013	ADAPTER 3/8"BARB X 3/4"MPT	4	6
MA-22014	ADAPTER 3/4"BARB X 3/4"MPT	4	6
MA-22117	ELBOW 1/2"BARB X 3/4"MPT	4	5
MA-22120	ELBOW 5/8"BARB X 3/4"MPT	4	5
MA-22122	ELBOW 3/4"BARB X 3/4"MPT	4	5
MA-22153	ELBOW 1/2"BARB	4	4
MA-22154	ELBOW 5/8"BARB	4	6
MA-22157	TEE 1/4"BARB	5	4
MA-22160	TEE 1/2"BARB	4	4
MA-22161	TEE 5/8"BARB	4	6
MA-22186	ADAPTER 5/8"BARB X 3/4"FPT	4	5
MA-22187	ADAPTER 3/4"BARB X 3/4"FPT	4	4
MA-22192	ELBOW 3/4"BARB	3	5
MA-22286	TEE 3/4"BARB	4	4
CR-RACK	COUNTER DISPLAY RACK	1	1
CR-HOOKS	HOOKS FOR COUNTER	1	21

PART #	DESCRIPTION	PKG.	TYPE
MA-22157	TEE 1/4" BARB	5	A
MA-22157-25	TEE 1/4" BARB	25	A
MA-22157-50	TEE 1/4" BARB	50	A
MA-22157-100	TEE 1/4" BARB	100	A
MA-22159	TEE 3/8" BARB	5	A
MA-22159-25	TEE 3/8" BARB	25	A
MA-22159-50	TEE 3/8" BARB	50	A
MA-22159-100	TEE 3/8" BARB	100	A
MA-22160	TEE 1/2" BARB	4	A
MA-22160-25	TEE 1/2" BARB	25	A
MA-22160-50	TEE 1/2" BARB	50	A
MA-22160-100	TEE 1/2" BARB	100	A
MA-22161	TEE 5/8" BARB	4	A
MA-22161-25	TEE 5/8" BARB	25	A
MA-22161-50	TEE 5/8" BARB	50	A
MA-22161-100	TEE 5/8" BARB	100	A
MA-22286	TEE 3/4" BARB	4	A
MA-22286-25	TEE 3/4" BARB	25	A
MA-22286-50	TEE 3/4" BARB	50	A
MA-22286-100	TEE 3/4" BARB	100	A
MA-22289	TEE 3/4" X 1/2" X 1/2" BARB	4	A
MA-22289-25	TEE 3/4" X 1/2" X 1/2" BAR	25	A

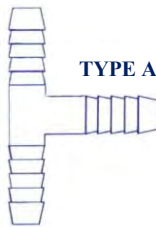

PART #	DESCRIPTION	PKG.	TYPE
MA-22289-50	TEE 3/4" X 1/2" X 1/2" BARB	50	A
MA-22289-100	TEE 3/4" X 1/2" X 1/2" BARB	100	A
MA-22290	TEE 1/2"MPT X 1/2"B X 1/2" B	4	A
MA-22290-25	TEE 1/2"MPT X 1/2"B X 1/2" B	25	A
MA-22290-50	TEE 1/2"MPT X 1/2"B X 1/2" B	50	A
MA-22290-100	TEE 1/2"MPT X 1/2"B X 1/2" B	100	A
MA-TN5044	NIPPLE 1/4"MPT X 1/4"MPT	4	O
MA-TN5044-25	NIPPLE 1/4"MPT X 1/4"MPT	25	O
MA-TN5044-50	NIPPLE 1/4"MPT X 1/4"MPT	50	O
MA-TN5044-100	NIPPLE 1/4"MPT X 1/4"MPT	100	O
MA-TN5066	NIPPLE 3/8"MPT X 3/8"MPT	4	O
MA-TN5066-25	NIPPLE 3/8"MPT X 3/8"MPT	25	O
MA-TN5066-50	NIPPLE 3/8"MPT X 3/8"MPT	50	O
MA-TN5066-100	NIPPLE 3/8"MPT X 3/8"MPT	100	O
MA-TN5088	NIPPLE 1/2"MPT X 1/2"MPT	4	O
MA-TN5088-25	NIPPLE 1/2"MPT X 1/2"MPT	25	O
MA-TN5088-50	NIPPLE 1/2"MPT X 1/2"MPT	50	O
MA-TN5088-100	NIPPLE 1/2"MPT X 1/2"MPT	100	O
MA-TN51212	NIPPLE 3/4"MPT X 3/4"MPT	4	O
MA-TN51212-25	NIPPLE 3/4"MPT X 3/4"MPT	25	O
MA-TN51212-50	NIPPLE 3/4"MPT X 3/4"MPT	50	O
MA-TN51212-100	NIPPLE 3/4"MPT X 3/4"MPT	100	O

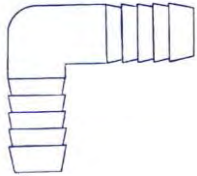
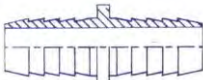
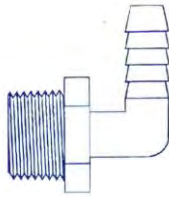
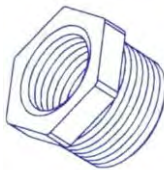
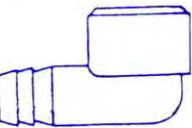
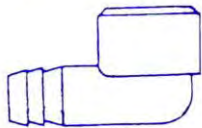
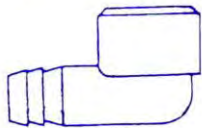
PART #	DESCRIPTION	PKG. TYPE	NYLON FITTINGS		PART #	DESCRIPTION	PKG. TYPE
MA-22151	ELBOW 1/4" BARB	5 B		<p>TYPE B</p>	MA-22122	ELBOW 3/4" B X 3/4" MPT	4 D
MA-22151-25	ELBOW 1/4" BARB	25 B			MA-22122-25	ELBOW 3/4" B X 3/4" MPT	25 D
MA-22151-50	ELBOW 1/4" BARB	50 B			MA-22122-50	ELBOW 3/4" B X 3/4" MPT	50 D
MA-22151-100	ELBOW 1/4" BARB	100 B			MA-22122-100	ELBOW 3/4" B X 3/4" MPT	100 D
MA-22152	ELBOW 3/8" BARB	5 B			MA-22065	ELBOW 1/2" B X 3/4" FPT	4 G
MA-22152-25	ELBOW 3/8" BARB	25 B			MA-22065-25	ELBOW 1/2" B X 3/4" FPT	25 G
MA-22152-50	ELBOW 3/8" BARB	50 B			MA-22065-50	ELBOW 1/2" B X 3/4" FPT	50 G
MA-22152-100	ELBOW 3/8" BARB	100 B			MA-22065-100	ELBOW 1/2" B X 3/4" FPT	100 G
MA-22153	ELBOW 1/2" BARB	4 B			MA-22064	ELBOW 5/8" B X 3/4" FPT	4 G
MA-22153-25	ELBOW 1/2" BARB	25 B			MA-22064-25	ELBOW 5/8" B X 3/4" FPT	25 G
MA-22153-50	ELBOW 1/2" BARB	50 B	MA-22064-50	ELBOW 5/8" B X 3/4" FPT	50 G		
MA-22153-100	ELBOW 1/2" BARB	100 B	MA-22064-100	ELBOW 5/8" B X 3/4" FPT	100 G		
MA-22154	ELBOW 5/8" BARB	4 B		<p>TYPE C</p>	MA-22066	ELBOW 3/4" B X 3/4" FPT	4 G
MA-22154-25	ELBOW 5/8" BARB	25 B			MA-22066-25	ELBOW 3/4" B X 3/4" FPT	25 G
MA-22154-50	ELBOW 5/8" BARB	50 B			MA-22066-50	ELBOW 3/4" B X 3/4" FPT	50 G
MA-22154-100	ELBOW 5/8" BARB	100 B	MA-22066-100	ELBOW 3/4" B X 3/4" FPT	100 G		
MA-22192	ELBOW 3/4" BARB	3 B		<p>TYPE D</p>	MA-22031	CONNECTOR 1/4" BARB	5 C
MA-22192-25	ELBOW 3/4" BARB	25 B			MA-22031-25	CONNECTOR 1/4" BARB	25 C
MA-22192-50	ELBOW 3/4" BARB	50 B			MA-22031-50	CONNECTOR 1/4" BARB	50 C
MA-22192-100	ELBOW 3/4" BARB	100 B			MA-22031-100	CONNECTOR 1/4" BARB	100 C
MA-22263	ELBOW 1/4" B X 1/4" MPT	5 D		<p>TYPE E</p>	MA-12032	CONNECTOR 3/8" BARB	5 C
MA-22263-25	ELBOW 1/4" B X 1/4" MPT	25 D			MA-12032-25	CONNECTOR 3/8" BARB	25 C
MA-22263-50	ELBOW 1/4" B X 1/4" MPT	50 D			MA-12032-50	CONNECTOR 3/8" BARB	50 C
MA-22263-100	ELBOW 1/4" B X 1/4" MPT	100 D			MA-12032-100	CONNECTOR 3/8" BARB	100 C
MA-22264	ELBOW 1/4" B X 3/8" MPT	4 D		<p>TYPE F</p>	MA-12033	CONNECTOR 1/2" BARB	4 C
MA-22264-25	ELBOW 1/4" B X 3/8" MPT	25 D			MA-12033-25	CONNECTOR 1/2" BARB	25 C
MA-22264-50	ELBOW 1/4" B X 3/8" MPT	50 D			MA-12033-50	CONNECTOR 1/2" BARB	50 C
MA-22264-100	ELBOW 1/4" B X 3/8" MPT	100 D	MA-12033-100	CONNECTOR 1/2" BARB	100 C		
MA-22112	ELBOW 3/8" B X 3/8" MPT	4 D		<p>TYPE G</p>	MA-12034	CONNECTOR 5/8" BARB	4 C
MA-22112-25	ELBOW 3/8" B X 3/8" MPT	25 D			MA-12034-25	CONNECTOR 5/8" BARB	25 C
MA-22112-50	ELBOW 3/8" B X 3/8" MPT	50 D			MA-12034-50	CONNECTOR 5/8" BARB	50 C
MA-22112-100	ELBOW 3/8" B X 3/8" MPT	100 D			MA-12034-100	CONNECTOR 5/8" BARB	100 C
MA-22113	ELBOW 3/8" B X 1/2" MPT	4 D		<p>TYPE G</p>	MA-12035	CONNECTOR 3/4" BARB	3 C
MA-22113-25	ELBOW 3/8" B X 1/2" MPT	25 D			MA-12035-25	CONNECTOR 3/4" BARB	25 C
MA-22113-50	ELBOW 3/8" B X 1/2" MPT	50 D			MA-12035-50	CONNECTOR 3/4" BARB	50 C
MA-22113-100	ELBOW 3/8" B X 1/2" MPT	100 D			MA-12035-100	CONNECTOR 3/4" BARB	100 C
MA-22114	ELBOW 3/8" B X 3/4" MPT	4 D			MA-12052	BUSHING 1/2" MPT X 3/8" FPT	4 E
MA-22114-25	ELBOW 3/8" B X 3/4" MPT	25 D			MA-12052-25	BUSHING 1/2" MPT X 3/8" FPT	25 E
MA-22114-50	ELBOW 3/8" B X 3/4" MPT	50 D			MA-12052-50	BUSHING 1/2" MPT X 3/8" FPT	50 E
MA-22114-100	ELBOW 3/8" B X 3/4" MPT	100 D			MA-12052-100	BUSHING 1/2" MPT X 3/8" FPT	100 E
MA-22116	ELBOW 1/2" B X 1/2" MPT	4 D			MA-12053	BUSHING 3/4" MPT X 1/2" FPT	4 E
MA-22116-25	ELBOW 1/2" B X 1/2" MPT	25 D			MA-12053-25	BUSHING 3/4" MPT X 1/2" FPT	25 E
MA-22116-50	ELBOW 1/2" B X 1/2" MPT	50 D	MA-12053-50	BUSHING 3/4" MPT X 1/2" FPT	50 E		
MA-22116-100	ELBOW 1/2" B X 1/2" MPT	100 D	MA-12053-100	BUSHING 3/4" MPT X 1/2" FPT	100 E		
MA-22117	ELBOW 1/2" B X 3/4" MPT	4 D	MA-12054	BUSHING 1" MPT X 3/4" FPT	4 E		
MA-22117-25	ELBOW 1/2" B X 3/4" MPT	25 D	MA-12054-25	BUSHING 1" MPT X 3/4" FPT	25 E		
MA-22117-50	ELBOW 1/2" B X 3/4" MPT	50 D	MA-12054-50	BUSHING 1" MPT X 3/4" FPT	50 E		
MA-22117-100	ELBOW 1/2" B X 3/4" MPT	100 D	MA-12054-100	BUSHING 1" MPT X 3/4" FPT	100 E		
MA-22120	ELBOW 5/8" B X 3/4" MPT	4 D	MA-12055	BUSHING 1-1/4" MPT X 1" FPT	1 E		
MA-22120-25	ELBOW 5/8" B X 3/4" MPT	25 D	MA-12056	BUSHING 1-1/2" MPT X 1-1/4" FPT	1 E		
MA-22120-50	ELBOW 5/8" B X 3/4" MPT	50 D	MA-12057	BUSHING 2" MPT X 1-1/2" FPT	1 E		
MA-22120-100	ELBOW 5/8" B X 3/4" MPT	100 D					

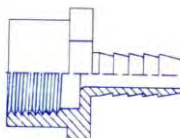
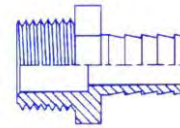
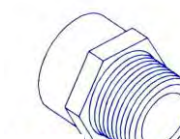
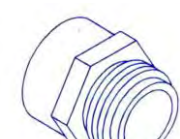
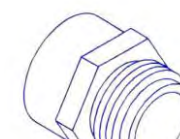
PART #	DESCRIPTION	PKG.	TYPE	NYLON FITTINGS	PART #	DESCRIPTION	PKG.	TYPE
MA-22182	ADAPTOR 1/2"B X 1/2" FPT	4	F	 <p>TYPE F</p>	MA-22013	ADAPTOR 3/8"B X 3/4" MPT	4	H
MA-22182-25	ADAPTOR 1/2"B X 1/2" FPT	25	F		MA-22013-25	ADAPTOR 3/8"B X 3/4" MPT	25	H
MA-22182-50	ADAPTOR 1/2"B X 1/2" FPT	50	F		MA-22013-50	ADAPTOR 3/8"B X 3/4" MPT	50	H
MA-22182-100	ADAPTOR 1/2"B X 1/2" FPT	100	F		MA-22013-100	ADAPTOR 3/8"B X 3/4" MPT	100	H
MA-22185	ADAPTOR 1/2"B X 3/4" FPT	4	F		MA-22010	ADAPTOR 1/2"B X 3/4" MPT	4	H
MA-22185-25	ADAPTOR 1/2"B X 3/4" FPT	25	F		MA-22010-25	ADAPTOR 1/2"B X 3/4" MPT	25	H
MA-22185-50	ADAPTOR 1/2"B X 3/4" FPT	50	F		MA-22010-50	ADAPTOR 1/2"B X 3/4" MPT	50	H
MA-22185-100	ADAPTOR 1/2"B X 3/4" FPT	100	F		MA-22010-100	ADAPTOR 1/2"B X 3/4" MPT	100	H
MA-22186	ADAPTOR 5/8"B X 3/4" FPT	4	F		MA-22012	ADAPTOR 5/8"B X 3/4" MPT	4	H
MA-22186-25	ADAPTOR 5/8"B X 3/4" FPT	25	F		MA-22012-25	ADAPTOR 5/8"B X 3/4" MPT	25	H
MA-22186-50	ADAPTOR 5/8"B X 3/4" FPT	50	F	MA-22012-50	ADAPTOR 5/8"B X 3/4" MPT	50	H	
MA-22186-100	ADAPTOR 5/8"B X 3/4" FPT	100	F	MA-22012-100	ADAPTOR 5/8"B X 3/4" MPT	100	H	
MA-22187	ADAPTOR 3/4"B X 3/4" FPT	4	F	MA-22014	ADAPTOR 3/4"B X 3/4" MPT	4	H	
MA-22187-25	ADAPTOR 3/4"B X 3/4" FPT	25	F	MA-22014-25	ADAPTOR 3/4"B X 3/4" MPT	25	H	
MA-22187-50	ADAPTOR 3/4"B X 3/4" FPT	50	F	MA-22014-50	ADAPTOR 3/4"B X 3/4" MPT	50	H	
MA-22187-100	ADAPTOR 3/4"B X 3/4" FPT	100	F	MA-22014-100	ADAPTOR 3/4"B X 3/4" MPT	100	H	
MA-22002	ADAPTOR 1/4"B X 1/4" MPT	10	H	 <p>TYPE I</p>	MA-12010	ADAPTOR 3/4"MGHT X 3/4" FPT	4	K
MA-22002-25	ADAPTOR 1/4"B X 1/4" MPT	25	H		MA-12010-25	ADAPTOR 3/4"MGHT X 3/4" FPT	25	K
MA-22002-50	ADAPTOR 1/4"B X 1/4" MPT	50	H		MA-12010-50	ADAPTOR 3/4"MGHT X 3/4" FPT	50	K
MA-22002-100	ADAPTOR 1/4"B X 1/4" MPT	100	H		MA-12010-100	ADAPTOR 3/4"MGHT X 3/4" FPT	100	K
MA-22003	ADAPTOR 1/4"B X 3/8" MPT	10	H	 <p>TYPE J</p>	MA-12004	ADAPTOR 3/4"MGHT X 3/4" MPT	4	I
MA-22003-25	ADAPTOR 1/4"B X 3/8" MPT	25	H		MA-12004-25	ADAPTOR 3/4"MGHT X 3/4" MPT	25	I
MA-22003-50	ADAPTOR 1/4"B X 3/8" MPT	50	H		MA-12004-50	ADAPTOR 3/4"MGHT X 3/4" MPT	50	I
MA-22003-100	ADAPTOR 1/4"B X 3/8" MPT	100	H		MA-12004-100	ADAPTOR 3/4"MGHT X 3/4" MPT	100	I
MA-22005	ADAPTOR 3/8"B X 3/8" MPT	10	H	 <p>TYPE K</p>	MA-12060	ADAPTOR 3/4"MGHT X 3/4" FGHT	3	K
MA-22005-25	ADAPTOR 3/8"B X 3/8" MPT	25	H		MA-12060-25	ADAPTOR 3/4"MGHT X 3/4" FGHT	25	K
MA-22005-50	ADAPTOR 3/8"B X 3/8" MPT	50	H		MA-12060-50	ADAPTOR 3/4"MGHT X 3/4" FGHT	50	K
MA-22005-100	ADAPTOR 3/8"B X 3/8" MPT	100	H		MA-12060-100	ADAPTOR 3/4"MGHT X 3/4" FGHT	100	K
MA-22006	ADAPTOR 3/8"B X 1/2" MPT	8	H	 <p>TYPE L</p>	MA-22048	ADAPTOR 3/4"FGHT X 5/8"B	4	L
MA-22006-25	ADAPTOR 3/8"B X 1/2" MPT	25	H		MA-22048-25	ADAPTOR 3/4"FGHT X 5/8"B	25	L
MA-22006-50	ADAPTOR 3/8"B X 1/2" MPT	50	H		MA-22048-50	ADAPTOR 3/4"FGHT X 5/8"B	50	L
MA-22006-100	ADAPTOR 3/8"B X 1/2" MPT	100	H		MA-22048-100	ADAPTOR 3/4"FGHT X 5/8"B	100	L
MA-22007	ADAPTOR 1/2"B X 3/8" MPT	8	H	MA-22049	ADAPTOR 3/4"FGHT X 3/4"B	4	L	
MA-22007-25	ADAPTOR 1/2"B X 3/8" MPT	25	H	MA-22049-25	ADAPTOR 3/4"FGHT X 3/4"B	25	L	
MA-22007-50	ADAPTOR 1/2"B X 3/8" MPT	50	H	MA-22049-50	ADAPTOR 3/4"FGHT X 3/4"B	50	L	
MA-22007-100	ADAPTOR 1/2"B X 3/8" MPT	100	H	MA-22049-100	ADAPTOR 3/4"FGHT X 3/4"B	100	L	
MA-22009	ADAPTOR 1/2"B X 1/2" MPT	6	H	MA-12013	ADAPTOR 3/4"MPT X 3/4"FGHT	4	J	
MA-22009-25	ADAPTOR 1/2"B X 1/2" MPT	25	H	MA-12013-25	ADAPTOR 3/4"MPT X 3/4"FGHT	25	J	
MA-22009-50	ADAPTOR 1/2"B X 1/2" MPT	50	H	MA-12013-50	ADAPTOR 3/4"MPT X 3/4"FGHT	50	J	
MA-22009-100	ADAPTOR 1/2"B X 1/2" MPT	100	H	MA-12013-100	ADAPTOR 3/4"MPT X 3/4"FGHT	100	J	

FERNCO FLEXIBLE COUPLINGS



CI = CAST IRON
PL = PLASTIC
ST = STEEL
C = COPPER
L = LEAD

MA-1056-075
3/4" CI/PL/C/ST/L TO 3/4" & 1"
CI/PL/C/ST/L
MA-1056-100
1" CI/PL/C/ST/L TO 1-1/4"
CI/PL/C/ST/L
MA-1056-22
2" CI/PL/C/ST/L TO 2"
CI/PL/C/ST/L

MA-1056-33
3" CI/PL/C/ST/L TO 3"
CI/PL/C/ST/L
MA-1056-44
4" CI/PL/C/ST/L TO 4"
CI/PL/C/ST/L
MA-1056-32
3" CI/PL/C/ST/L TO 2"
CI/PL/C/ST/L

DO NOT LOOK DIRECTLY INTO THE LIGHTS

**3W COB
HEAD LAMP
MA-HML3C**

FUNCTIONS :
HIGH - LOW - STROBE
ROTATES 180°

INCLUDES :
(3) AAA BATTERIES



**2W COB
TOGGLE STYLE
LIGHT SWITCH
MA-465**

INCLUDES :
(3) AAA BATTERIES
MAGNET & VELCRO TAPE



**MA-492B
BLACK**



**MA-492W
WHITE**

2W COB EURO STYLE LIGHT SWITCH

INCLUDES : (4) AAA BATTERIES, MAGNET & VELCRO TAPE



LED/COB FLASHLIGHT

MA-FL1438

FUNCTION :
HEAD
ROTATES TO
90° ANGLE

INCLUDES :
(4) AAA
BATTERIES

**3W COB
WORK LIGHT
MA-FL1063C**

FUNCTIONS :
ROTATES 360°
BLACK METAL BRACKET
HAS TWO MAGNETS

INCLUDES :
(4) AAA BATTERIES



**1W LED FLASHLIGHT &
3W COB WORKLIGHT**

MA-FL296C



**1W LED FLASHLIGHT &
3W COB WORKLIGHT**

180° ADJ. HEAD - STRONG MAGNET ON BASE & HOOK

MA-FL6287



**BUY 12 AND
GET A FREE
COUNTER
DISPLAY BOX**

DO NOT LOOK DIRECTLY INTO THE LIGHTS
MA-FL3A
**3 LED EXTENDABLE
FLASHLIGHT
WITH FLEXIBLE NECK**
INCLUDES: (4) LR44



STRONG MAGNET ON BASE TO ADHERE
TO METAL SURFACES
MAGNET ON HEAD TO PICKUP METAL
PIECES IN HARD TO REACH SPACES
EXTENDS FROM 6.5" TO 20"
2" FLEXIBLE NECK



395 – 415NM
WAVE
LENGTH

MA-FL3BUV
3 UV LED EXTENDABLE FLASHLIGHT
WITH FLEXIBLE NECK
INCLUDES: (4) LR44

STRONG MAGNET ON BASE TO ADHERE
TO METAL SURFACES
MAGNET ON HEAD TO PICKUP METAL
PIECES IN HARD TO REACH SPACES
EXTENDS FROM 6.5" TO 20"
2" FLEXIBLE NECK



MA-PBL1 BAT LIGHT
MATERIAL:
ANODIZED ALUMINUM WITH RUBBER COVER
3 FUNCTIONS: HIGH, LOW & TACTICAL STROBE
INCLUDES: (3) AA BATTERIES



MA-FL460
**4 LED
FLASHLIGHT
60 LED WORK
LIGHT**
INCLUDES:
FOLDING STAND,
HOOK, MAGNET
& (3) AAA
BATTERIES

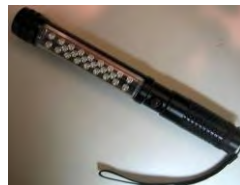

MA-AP3172
**8 LED FLASHLIGHT
25 LEDWORK LIGHT
& 1 LASER**

INCLUDES: (3) AAA BATTERIES

MA-AP132
**6 LED PEN
LIGHT**
INCLUDES:
MAGNET POCKET
CLIP
&
(3) AAA BATTERIES



MA-1001
(12/CTN)
MAGNA-LITE JR

MA-2001
(1/PKG)
MAGNA-LITE SR.



MAGNA-LITE

INDUSTRIAL GRADE BATTERIES

MA-303/357RB LR44 1/PKG
MA-ALD D ALKALINE
6/PKG – 72/CASE
MA-ALC C ALKALINE
6/PKG – 72/CASE
MA-ALAA AA ALKALINE
8/PKG – 96/CASE
MA-ALAAA AAA ALKALINE
8/PKG – 96/CASE
MA-AL9V 9V ALKALINE
6/PKG – 72/CASE



DO NOT LOOK DIRECTLY INTO THE LIGHTS



MA-LF462C
COB
COLLAPSIBLE
LANTERN

INCLUDES:
(3) AAA BATTERIES



MA-WL10C
10W COB
PORTABLE
WORK LIGHT

570 LUMENS
ON/OFF SWITCH
180° SWIVEL STAND BASE
(2) MAGNETS ON BASE

INCLUDES:
(4) AA BATTERIES



MA-748325A
180° ADJUSTABLE
WORKLIGHT
WITH 25' CORD
METAL GUARD
MAGNET ON BASE



MA-RPW20
20W COB
RECHARGABLE
PORTABLE
WORK LIGHT
2000 LUMENS

INCLUDES:
CAR CHARGER &
AC/DC CHARGER



ALL-WEATHER
EXTENSION
CORDS



- MA-73093** 50 FT. 12/3 SJEOW (6/CASE)
- MA-74213** 100 FT. 12/3 SJEOW (4/CASE)
- MA-60743** 50 FT. 12/3 SJTW (6/CASE)
- MA-72023** 100 FT. 12/3 SJTW (4/CASE)
- MA-70474** 25 FT. 14/3 SJTW (12/CASE)
- MA-63493** 50 FT. 14/3 SJTW (6/CASE)
- MA-61623** 100 FT. 14/3 SJTW (6/CASE)
- MA-65093** 25 FT. 16/3 SJTW (12/CASE)
- MA-63223** 50 FT. 16/3 SJTW (12/CASE)
- MA-67363** 100 FT. 16/3 SJTW (6/CASE)

TROUBLE LIGHT
WITH SWITCH & OUTLET

- MA-71493**
25' 16/3 SJT WITH METAL GUARD
SWITCH & OUTLET TROUBLE LIGHT
- MA-70343**
50' 16/3 SJT WITH METAL GUARD
SWITCH & OUTLET TROUBLE LIGHT



REPLACEMENT
POWER SUPPLY
CORDS



- MA-09857** 6' 14/3 BLACK 3 CONDUCTOR
SJE00W, 125V, 15 AMP RATING
- MA-09858** 9' 14/3 BLACK 3 CONDUCTOR
SJE00W, 125V, 15 AMP RATING
- MA-09709** 9' 16/3 BLACK 3 CONDUCTOR
SJTW, 125V, 13 AMP RATING

AIR CONDITIONING
EXTENSION CORDS



- MA-03532** 6 FT. 14/3 BEIGE, SPT3,
RIGHT ANGLE, MALE PLUG, 15A-125V
(24/CASE)
- MA-03533** 9 FT. 14/3 BEIGE, SPT3,
RIGHT ANGLE, MALE PLUG, 15A-125V
(18/CASE)

HANDI-TAP 3-OUTLET
EXTENSION CORDS

ORANGE

- MA-72314** 2 FT. 12/3 STW, 15A
- MA-71354** 25 FT. 12/3 SJTW, 15A
- MA-72744** 50 FT. 12/3 SJTW, 15A
- MA-62044** 100 FT. 12/3 SJTW, 15A
- MA-61834** 25 FT. 14/3 SJTW, 15A
- MA-60954** 50 FT. 14/3 SJTW, 15A
- MA-70204** 100 FT. 14/3 SJTW, 15A

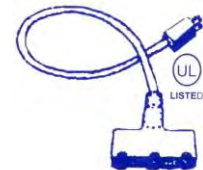



MA-CL1
CAPILLARY TUBE CUTTER



MA-VTC1
VINYL TUBING CUTTER

CUTS VINYL TUBING,
 PVC PIPE AND
 RUBBER TUBING



MA-49317
INNER/OUTER STEEL REAMER
 CAPACITY: 1/8" TO 1-5/8" OD



MA-MFC1

FIN COMBS

MA-MFC1
 ALL METAL
 FIN COMB

MA-MFC2

MA-MFC2
 METAL FIN COMB
 WITH HANDLE

MA-MFC3

MA-MFC3
 6 IN 1 FIN COMBS
 8, 9, 10, 12, 14,
 & 15 FINS/INCH

**TORQUE AND
 HEX KEY SETS**

MA-88057

7PC. TORQUE FOLD UP SET
 T10, T15, T20, T25, T27, T30 & T40

MA-88081

8PC. HEX KEY FOLD UP SET
 .050", 1/16", 5/64", 3/32", 7/64",
 1/8", 9/64" & 5/32"

MA-88091

9PC. HEX KEY FOLD UP SET
 5/64", 3/32", 7/64", 1/8", 9/64",
 5/32", 3/16", 7/32" & 1/4"

MA-1200

7PC HEX KEY SET - 6" LONG
 3/32", 5/64", 1/8", 5/32", 3/16",
 7/32" & 1/4"

MA-1201

7PC HEX KEY SET
 12" LONG - 3/32", 5/64", 1/8", 5/32",
 3/16", 7/32" & 1/4"

MA-1202

8PC T-HANDLE HEX WRENCH SET -
 9" LONG - 3/32", 7/64", 1/8", 9/64",
 5/32", 3/16", 7/32" & 1/4"

MA-88057
 MA-88081
 MA-88091



MA-1200 6" Long
 MA-1201 12" Long



HUB PULLER
 PULLS OFF FAN BLADES AND
 BLOWER WHEELS

MA-FB2



DEBURRING TOOLS

MA-49310

DELUXE DE-BURRING
 TOOL

MA-49314

REPLACEMENT BLADES
 FOR THE MA-49310



MA-49316

ALL METAL DE-BURRING
 TOOL WITH FIXED BLADE



6 IN 1 SWAGING TOOL

3/16", 1/4", 5/16", 3/8", 1/2" & 5/8" OD TUBING

MA-49318



**HOLE SAW
 KITS**

MA-NS1000 6PC. SAW KIT

3/4", 7/8", 1-1/8", 1-1/2", 1-3/4" & 2-1/4"
 PLUS MA-NS1 & MA-NS2 ARBORS

MA-NS2000 9PC. SAW KIT

3/4", 7/8", 1-1/8",
 1-3/8", 1-1/2", 1-3/4", 2", 2-1/4" & 2-1/2"
 PLUS MA-NS1, MA-NS2 & MA-NS3
 ARBORS & PILOT DRILL



REPLACEMENT SAWS, ARBORS & EXTENSIONS

MA-NS1 7/16" HEX SHANK ARBOR 9/16" TO 1-1/8" HOLE SAWS
 1/2" X 20 THREAD

MA-NS2 7/16" HEX SHANK ARBOR 1-1/4" TO 6" HOLE SAWS
 5/8" X 18 THREAD

BI METAL HOLE SAW

MA-NS12 3/4" **MA-NS14** 7/8" **MA-NS16** 1"

MA-NS18 1-1/8" **MA-NS22** 1-3/8" **MA-NS24** 1-1/2"

MA-NS26 1-5/8" **MA-NS28** 1-3/4" **MA-NS32** 2"

MA-NS36 2-1/4" **MA-NS40** 2-1/2"

MA-NSPD1 1/4" X 4" PILOT DRILL



MA-MAG1
MAGNETIZER & DEMAGNETIZER
MAGNETIZES AND DEMAGNETIZES TOOLS EASILY



MAGNETIZE:
LEAD TOOL SLOWLY THROUGH TOP SQUARE

DEMAGNETIZE:
LEAD TOOL SLOWLY THROUGH BOTTOM SQUARE

MA-RS121
STUBBY RATCHETING SCREWDRIVER



INCLUDES:
(1) RATCHETING SCREWDRIVER
(1) BIT HOLDER
(5) 25mm LONG PHILLIPS #1, #2 & #3 - SLOTTED #5 & #7
(6) 28mm LONG PHILLIPS #0, #00, #T8 & T9 SLOTTED #2.5 & #3



MA-9357
6 IN 1 HEAVY DUTY PLASTIC HANDLE SCREWDRIVER
12/CASE - PRICE PER EACH

REPLACEMENT BITS
LARGE REPLACEMENT MA-SDB2 - 1/4" SLOTTED & #2 PHILLIPS
REPLACEMENT BITS
SMALL REPLACEMENT MA-SDB8 - 3/16" SLOTTED & #1 PHILLIPS

MA-9358-12
6 IN 1 HEAVY DUTY RUBBER GRIP SCREWDRIVER
12/CASE - PRICE PER EACH



REPLACEMENT BITS
LARGE REPLACEMENT MA-SDB2 - 1/4" SLOTTED & #2 PHILLIPS
REPLACEMENT BITS
SMALL REPLACEMENT MA-SDB8 - 3/16" SLOTTED & #1 PHILLIPS



MA-TBS31
31PC. TRIANGLE BIT SET

INCLUDES:
(1) QUICK RELEASE BIT HOLDER

SLOTTED: 3, 4, 5, 6 & 7
PHILLIPS: 1, 2-2 & 3
POZI DRIVER: 1, 2 & 3
HEX: 2.5, 3, 4, 5 & 6
TORQUE: 10, 15, 20, 25, 27, 30 & 40
SQUARE: 1-1, 2-2 & 3-3

COLOR CODE:
ORANGE = TORQUE
BLUE = SLOTTED
GREEN = POZIDRIVE®
RED = PHILLIPS
YELLOW = HEX
PURPLE = SQUARE ACCESS



MA-AP8SD
8PC. SCREWDRIVER SET
4 SLOTTED - 4 PHILLIPS



MA-70059P
3PC. OFFSET SCREWDRIVER SET

MA-290
MULTI-BIT & DRIVER KIT
29PC. TOOL KIT
ASSORTED BITS WITH DRIVER & EXTENSION



MA-147B
13PC. DRILL SET
1/16" - 1/4"
IN ROUND CASE

ADJUSTABLE WRENCHES

- MA-WR6** 6"
- MA-WR8** 8"
- MA-WR10** 10"
- MA-WR12** 12"
- MA-WR681012** 6", 8", 10" & 12"



- KIT INCLUDES:** 24 pc. Assorted Bits
Plastic Carrying Case
1 Quick Change Adaptor
1 Bit Holder
4 Phillips Bits: #1, (2) #2 & #3 - 1" long
3 Slotted Bits: 6-8, 8-10 & 10-12 - 1" long
2 Torque Bits: T15, T20 - 1" long
3 Square Head Bits: S1, S2 & S3 - 1" long
5 Hex Head Bits: 3/32", 1/8", 5/32", 3/16", & 7/32" - 1" long
7 Drill Bits: 1/16", 3/32", 1/8", 5/32", 3/16"

QUICK CHANGE ADAPTOR KIT

MA-72066



RATCHETING WRENCHES WITH DUAL HEX ADAPTERS 3/16" & 5/16"



STRAIGHT
5-1/2"
&
6-3/4"

MA-70072 5-1/2" STRAIGHT - ONE END SQ. 3/16" & 1/4" - ONE END SQ. 5/16" & 3/8"

MA-70073 6-3/4" STRAIGHT - ONE END SQ. 3/16" & 1/4" - ONE END HEX 1/2" & 9/16"



OFFSET
5-1/2"

MA-70074 5-1/2" OFFSET - ONE END SQ. 3/16" & 1/4" - ONE END SQ. 5/16" & 3/8"

SPECIALTY TOOLS

- MA-114** FLEXIBLE MECHANICAL FINGERS 17-1/2" LONG
- MA-159A** DELUXE MAGNETIC TOOL WITH SWIVEL HEAD, PICKS UP TO 10LBS & EXTENDS TO 32"
- MA-186** SCRIBE (DUAL END)
- MA-185** TELESCOPIC FURNACE LIGHTER



MA-185



MA-159A

MA-114

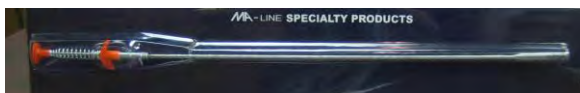

MA-186



QUICK CHANGE DRILL ADAPTOR

MA03500-2

MA-60609
HEX KEY ADAPTOR
MA-60610



HEX KEY ADAPTOR WITH STRAIGHT WRENCH

MA-60613

STRAIGHT WRENCH

1/4" & 3/16" AND 3/8" & 5/16"
(ALSO AVAILABLE **MA-60613-25** 25/PKG)



MA-60616

OFFSET WRENCH

1/4" & 3/16" AND 3/8" & 5/16"
(ALSO AVAILABLE **MA-60616-25** 25/PKG)



FLARE WRENCH SET

MA-49320 3 PC SET
3/8" X 7/16", 1/2" X 9/16" & 5/8" X 11/16" **MA-49320**



MA-49324 5 PC SET
1/4" X 5/16", 3/8" X 7/16", 1/2" X 9/16", 5/8" X 11/16" & 3/4" X 7/8" **MA-49324**



REPLACEMENT WRENCHES

- MA-49330** 1/4" X 5/16"
- MA-49331** 3/8" X 7/16" **MA-49333** 5/8" X 11/16"
- MA-49332** 1/2" X 9/16" **MA-49334** 3/4" X 7/8"

PIPE WRENCHES

STEEL

- MA-70091** 10" HEAVY DUTY
- MA-70093** 14" HEAVY DUTY
- MA-70094** 18" HEAVY DUTY
- MA-70095** 24" HEAVY DUTY

ALUMINUM

- MA-70097** 12" ALUMINUM
- MA-70098** 14" ALUMINUM
- MA-70099** 18" ALUMINUM
- MA-70100** 24" ALUMINUM



REVERSIBLE RATCHET WRENCH BIT KIT

MA-RRWBK



KIT INCLUDES: POLISHED FINISH
5-1/2" SQUARE OPENING, TOP END: 1/4" & 3/16"
BOTTOM END: 5/16" & 3/8" STRAIGHT
5-1/2" SQUARE OPENING, TOP END: 1/4" & 3/16"
BOTTOM END: 5/16" & 3/8" OFFSET
6-3/4" HEX OPENING: 1/2" & 9/16" SQUARE OPENING:
1/4" & 3/16" STRAIGHT
ADAPTER: 2-1/4" - 1/4" SQUARE X 3/16" HEX
ADAPTER: 2-1/4" - 1/4" SQUARE X 5/16" HEX

MA-NDK16 16 PC. HEX MAGNETIC NUT DRIVER KIT

INCLUDES:

1/4" X 1-3/4", 2-9/16", 4" AND 6"
5/16" X 1-3/4", 2-9/16", 4" AND 6"
3/8" X 1-3/4"

6PCS. SCREWDRIVER BITS
SLOTTED 1/4" HEX - 2" LONG - 3/16", 7/32" & 9/32"
PHILLIPS 1/4" HEX - 2" LONG - 0PT, 1PT & 2PT
1PC. QUICK CHANGE ADAPTOR



FLEXIBLE RATCHET WRENCH SET

MA-FWP7

U.S. STANDARD SIZE

REPLACEMENT WRENCHES

MA-FWP1/4 - 1/4" MA-FWP5/8 - 5/8"
MA-FWP1/2 - 1/2" MA-FWP7/16 - 7/16"
MA-FWP5/16 - 5/16" MA-FWP9/16 - 9/16"
MA-FWP3/8 - 3/8"

MA-FWP7-MET

METRIC SIZE

REPLACEMENT WRENCHES

MA-FWP6MM - 6MM MA-FWP13MM - 13MM
MA-FWP8MM - 8MM MA-FWP14MM - 14MM
MA-FWP10MM - 10MM MA-FWP16MM - 16MM
MA-FWP11MM - 11MM



8PC. FOLDING RATCHET BIT SET MA-FRBS8

INCLUDES:

1PC. FOLDING
RATCHET BIT DRIVER
1PC. 1/4" QUICK CHUCK
BIT ADAPTOR
6PC. 25MM BITS
2 SLOTTED - 2 PHILLIPS - 2 TORX



MA-SOC19 19PC. RATCHETING SOCKET SET

U.S. STANDARD SIZE

INCLUDES: 1/4" & 3/8"

1 PC. 3/8" DR. REV. RATCHET HANDLE
1 PC. 3/8" DR. EXTENSION BAR 3"
1 PC. 1/4" (M) X 3/8" (F) ADAPTOR
1 PC. 3/8" DR. SPARK PLUG SOCKET 5/8"
1 PC. 1/4" DR. SPINNER HANDLE 6"
11 PCS. 1/4" DR. SOCKETS 5/32", 3/16", 7/32",
1/4", 9/32", 5/16", 11/32", 3/8", 7/16", 15/32" AND 1/2"
3 PCS. 3/8" DR. SOCKETS 1/2", 9/16" AND 11/16"

MA-SOC19-MET - METRIC SIZE - INCLUDES: 6.35mm & 10mm

1 PC. 10mm DR. REVERSIBLE RATCHET HANDLE - 1 PC. 10mm DR. EXTENSION
BAR 75mm - 1 PC. 6.35mm (M) X 10mm (F) ADAPTOR - 1 PC. 10mm DR. SPARK
PLUG SOCKET 16mm - 1 PC. 6.35mm DR. SPINNER HANDLE 150mm - 11 PCS.
6.35mm DR. SOCKETS 4mm, 4.5mm, 5mm, 5.5mm, 6mm, 7mm, 8mm, 9mm, 10mm,
11mm and 12mm -
3 PCS. 10mm DR. SOCKETS 13mm, 14mm and 17mm



**“QUICK-PIERCE”
 REFRIGERANT RECOVERY TOOL**



MA-QP400
 RECOVERY TOOL
MA-QP400-12
 PIERCING TIP
 REPLACEMENT
 (1/PKG)
MA-QP400G
 GASKET ONLY

**LOCKING PINCH-OFF TOOL
 MA-1RR**



TONGUE AND GROOVE PLIERS PLIERS

MA-430G
 10" – CAPACITY 2" (A)
MA-440G
 12" – CAPACITY 2-1/4" (A)
STANDARD PATTERN PLIERS
MA-317G 7-1/2" LONG NOSE
 PLIERS WITH SIDE CUTTER (B)
MA-337 7" LAP JOINT
 DIAGONAL PLIER (C)



A



B



C

**REPLACEMENT
 DRIVERS
 HOLLOW SHAFTS**

MA-9306 3/16"
MA-9308 1/4"
MA-9310 5/16"
MA-9311 11/32"
MA-9312 3/8"
MA-9314 7/16"
MA-9316 1/2"



**7PC NUT DRIVER SET
 MA-9355**



**2PC. NUT DRIVER SET
 MA-ND14516
 1/4 & 5/16"
 WITH RUBBER GRIP**

MA-72433
 1" GASKET SCRAPER
MA-72439
 1-1/4" CHISEL
 SCRAPER
MA-72435
 1-1/4" PUTTY KNIFE
MA-72437
 3" PUTTY KNIFE

**SCRAPER &
 PUTTY
 KNIVES**

MA-72433
 MA-72439
 MA-72435
 MA-72437



**MA03200-2
 CRIMPING TOOL**



**MA03203-2
 DELUXE CUTTER & WIRE STRIPPER**



15 FUNCTION KNIFE
MA-KN15

15 FUNCTIONS:

- *MAIN BLADE
- *CAN OPENER
- *SCISSORS
- *FISH SCALER
- *HOOK REMOVER
- *PHILLIPS SCREWDRIVER
- *LEATHER PUNCH
- *NAIL CLEANER
- *NAIL FILE

FUNCTIONS CON'T:

- *NEEDLE THREADER
- *CORKSCREW
- *KEY RING
- *SLOTTED SCREWDRIVER
- *BOTTLE OPENER
- *SAW



CAMOUFLAGE KNIFE
MA-CKN1

STAINLESS STEEL 3-1/2" BLADE
4-1/2" CLOSED - 8" OPEN
INCLUDES: POCKET CLIP

BUY 6 AND GET A COUNTER DISPLAY BOX FREE

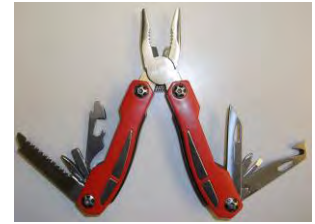

13 FUNCTION MULTI-TOOL
MA-MT13

13 FUNCTIONS:

- *NEEDLE NOSE PLIERS
- *REGULAR PLIER
- *WIRE CUTTER
- *SHARP KNIFE
- *SMALL SLOTTED SCREWDRIVER
- *MEDIUM SLOTTED SCREWDRIVER
- *LARGE SLOTTED SCREWDRIVER

FUNCTIONS CON'T:

- *PHILLIPS SCREWDRIVER
- *METAL/WOOD FILE
- *BELT CUTTER
- *BOTTLE OPENER
- *CAN OPENER
- *SAW

DUCTBOARD KNIFE & SHEATH
MA-KN74HD

STAINLESS STEEL * 1 SIDE SMOOTH * 1 SIDE SERRATED



SURGICAL STAINLESS STEEL POCKET KNIFE
MA-KC710

WITH HARDWOOD HANDLE
3-3/4" BLADE
5" CLOSED - 8-3/4" OPEN

MA-KVS008A



MA-KVS007A

STAINLESS STEEL POCKET KNIVES

MA-KVS007A 2" SMOOTH BLADE,
3" CLOSED - 5" OPEN
MA-KVS008A 2" SERRATED BLADE,
3" CLOSED - 5" OPEN



FOLDING KNIFE WITH SMOOTH/SERRATED BLADE
MA-AP890

3" BLADE - 4" CLOSED - 7" OPEN

FOLDING UTILITY KNIFE



MA-301C

INCLUDES:
(3) ADDITIONAL REPLACEMENT BLADES

DELUXE UTILITY CUTTER

MA-202

REPLACEMENT BLADES

MA-202RB



MINI-POCKET MULTI-TOOL
MA-MT62

14 FUNCTIONS:

- *BOTTLE OPENER
- *WIRE CUTTER
- *SMALL WIRE STRIPPER
- *LARGE WIRE STRIPPER
- *SMALL BLADE & PRY BAR
- *SERRATED BLADE
- *LARGE DROP POINT BLADE

PLIERS PLUS
MA-MT53

FUNCTIONS CON'T:

- *FILE
- *NEEDLE NOSE PLIER
- *REGULAR PLIER
- *SMALL SCREWDRIVER
- *PHILLIPS SCREWDRIVER
- *LARGE SCREWDRIVER



SNIPS

AVIATION SNIPS

MA-70250 CUTS LEFT (RED)

MA-70251 CUTS RIGHT (GREEN) AVIATION SNIPS

MA-70252 CUTS STRAIGHT (YELLOW)

OFFSET SNIPS

MA-70253 CUTS LEFT

MA-70254 CUTS RIGHT

TINNER SNIPS

MA-70255 7" LONG CUTS 1-3/4"

MA-70256 10" LONG CUTS 2-1/2"

MA-70257 12-1/2" LONG CUTS 3"



TINNER SNIPS

AVIATION SNIPS: Our 10" Aviation Snips from MA-Line meet Federal specifications ANSI/ASME B107-16-1985. They have blades that are made from drop forged AISI-6150 chrome vanadium steel, with serrated blade edges that have been induction harden. They are rated to cut up to 1.2mm cold rolled steel or .7mm AISI-304 stainless steel.

OFFSET SNIPS: Our Offset Snips have vinyl plastic handle guard grips. The offset blades keep hand above metal, eliminates interference with metal being cut. Cuts up to 1-1/2".

TINNER SNIPS: Our Tinner Snips have a straight pattern that is recommended when a powerful snip and a straight cut is desired. Our snips have polished blades and baked enamel handles.

HACKSAWS



MA-70-14JR

MA-132A

MA-70-14JR JUNIOR HACKSAW WITH BLADE

MA-71-132R BLADE ONLY FOR MA-70-14JR

MA-132A MINI-HACKSAW WITH BLADE

REPLACEMENT BLADES

MA-AA45E 12" HACKSAW BLADE, 18TPI (10/PKG)

MA-AA46V 12" HACKSAW BLADE, 24TPI (10/PKG)

MA-AA47R 12" HACKSAW BLADE, 32TPI (10/PKG)

SCREW STARTERS WITH MAGNET



MA-171 PHILLIPS HEAD 6" NYLON HANDLE

MA-174 SLOTTED HEAD 3" ALUMINUM HANDLE

MA-174D PHILLIPS HEAD 3" ALUMINUM HANDLE

MA-175D PHILLIPS HEAD 6" ALUMINUM HANDLE

MA-176E SLOTTED HEAD 9" NYLON HANDLE

POCKET LEVELS



MA-8400

ALUMINUM 5" POCKET LEVEL



MA-8408

MAGNETIC PVC 9" POCKET LEVEL

TAPE MEASURES

MA0126-12 1/2" X 12' WITH LOCK

MA0127-16 3/4" X 16' WITH LOCK

MA0128-25 1" X 25' WITH LOCK

MA0129-30 1" X 30' WITH LOCK



REEL TAPE

MA0130-50 3/8" X 50'

MA0131-100 3/8" X 100'

STEEL CALIPERS

MA-71801P STEEL CALIPER



The inexpensive and easy-to-use caliper from the MA-Line is made of all steel. Designed to measure in both inches and centimeters. Made to measure thickness or gauge of any type of metal as well as the ID or the OD of tubing or fittings

MA-71802P 6" DIAL CALIPER



The all stainless steel construction, shockproof unit measures in standard and metric. It comes with a deluxe storage case.

MA-71803P DIGITAL CALIPER



The Deluxe Digital Electronic Caliper represents the latest in technology at an economical price. The unit will measure in standard inches or metric. It comes with a deluxe storage case to protect this valuable instrument. The LED display is designed to measure at the speed of 60"/second or 1.5m/second. Also has a serial output for interface with a host computer or printer.

WIRE PVC CUTTER/SAW

MA-PVC27 27"

MA-PVC42 42"



These PVC Cutters are an easy, inexpensive and convenient way to cut PVC pipe. They come in two different lengths. The MA-PVC27 is for smaller size PVC pipe while the MA-PVC42 is for the larger (4" and up) size PVC pipe.

PVC PIPE CUTTERS

MA-S25 CUTS UP TO 1"

MA-L42 CUTS UP TO 1-1/4"

MA-L50 CUTS UP TO 2"



MA-S25RB REPLACEMENT BLADE FOR MA-S25

MA-L42RB REPLACEMENT BLADE FOR MA-L42

MA-L50RB REPLACEMENT BLADE FOR MA-L50

SLOTTED 1/4" HEX INSERT



- 1" LENGTH**
MA-9601 1/8" (3/PKG)
MA-9602 3/16" (3/PKG)
MA-9603 7/32" (3/PKG)
MA-9604 9/32" (3/PKG)
2" LENGTH
MA-9605 3/16" (2/PKG)
MA-9606 7/32" (2/PKG)
MA-9607 9/32" (2/PKG)
2-3/4" LENGTH
MA-9608 3/16" (2/PKG)
MA-9609 7/32" (2/PKG)
MA-9610 9/32" (2/PKG)
ASSORTMENT 2" LENGTH
MA03542-2 3/16", 7/32"& 9/32" (3/PKG)

PHILLIPS 1/4" HEX INSERT



- 1" LENGTH**
MA-9611 0 PT (3/PKG)
MA-9612 1 PT (3/PKG)
MA-9613 2 PT (3/PKG)
MA-9614 3 PT (3/PKG)
2" LENGTH
MA-9615 0 PT (2/PKG)
MA-9616 1 PT (2/PKG)
MA-9617 2 PT (2/PKG)
MA-9618 3 PT (2/PKG)
2-3/4" LENGTH
MA-9619 1 PT (2/PKG)
MA-9620 2 PT (2/PKG)
MA-9621 3 PT (2/PKG)
ASSORTMENT 2" LENGTH
MA03543-2 1, 2, 3 PT (3/PKG)

DOUBLE WAY 2/PKG

- MA-9658** 1X4MM
MA-9659 2X5MM
MA-9660 2.5X5MM
MA-9661 3X6MM



POZIDRIVE 1/4" HEX INSERT

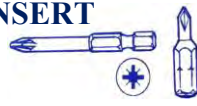

- 1" LENGTH - (3/PKG)** **2" LENGTH - (2/PKG)**
MA-9646 1 PT **MA-9648** 1 PT
MA-9647 2 PT **MA-9649** 2 PT

PLATED SHEET METAL SCREWS

HEX WASHER HEAD SELF DRILLING UNSLOTTED SCREWS

- MA03758-1** 8 X 1/2" (20/BAG)
MA03759-1 8 X 3/4" (18/BAG)
MA03760-1 8 X 1" (16/BAG)
MA03761-1 10 X 1/2" (14/BAG)
MA03762-1 10 X 3/4" (12/BAG)
MA03763-1 10 X 1" (10/BAG)

BAGS - 100 PCS

- MA03758-2** 8 X 1/2"
MA03759-2 8 X 3/4"
MA03760-2 8 X 1"
MA03761-2 10 X 1/2"
MA03762-2 10 X 3/4"
MA03763-2 10 X 1"

TUBS - 500 PCS

- MA03758-3** 8 X 1/2"
MA03759-3 8 X 3/4"
MA03760-3 8 X 1"
MA03761-3 10 X 1/2"
MA03762-3 10 X 3/4"
MA03763-3 10 X 1"



HEX WASHER HEAD FAST PENETRATING HEAD SLOTTED SCREWS

BAGS - 100 PCS

- MA03414-2** 7 X 1/2"
MA03415-2 8 X 1/2"
MA03416-2 8 X 3/4"
MA03417-2 10 X 1/2"
MA03565-2 8 X 1"
MA03566-2 10 X 3/4"
MA03567-2 10 X 1"

TUBS - 500 PCS

- MA03565-3** 8 X 1"
MA03567-3 10 X 1"
TUBS - 1000 PCS
MA03414-4 7 X 1/2"
MA03415-4 8 X 1/2"
MA03416-4 8 X 3/4"
MA03417-4 10 X 1/2"
MA03566-4 10 X 3/4"



**MA-MGT1
MAGNETIC PARTS TRAY ROUND**

1-5/8" LENGTH

- MA03539-2** 1/4"
MA03540-2 5/16"
MA03541-2 3/8"
MA09353-2 1/4" & 5/16"
MA09354-2 1/4", 5/16" & 3/8"

MAGNETIC CHUCKS

FOR ELECTRIC DRILLS AND POWER SCREWDRIVERS

2-9/16" LENGTH

- MA03544-2** 1/4"
MA03545-2 5/16"
MA03546-2 3/8"



POINT OF PURCHASE DISPLAY CARD
24 PCS. PER CARD

- MA03539-24** 1/4" X 1-5/8"
MA03540-24 5/16" X 1-5/8"
MA03541-24 3/8" X 1-5/8"

MA0353940-MX

(12) 1/4" X 1-5/8" & (12) 5/16" X 1-5/8"

POINT OF PURCHASE DISPLAY CARD FOR COUNTER TOP OR HANG ON RACK



TORQ 1/4" HEX INSERT



- 1" LENGTH**
MA-9622 T-10 (3/PKG)
MA-9623 T-15 (3/PKG)
MA-9624 T-20 (3/PKG)
MA-9625 T-25 (3/PKG)
MA-9626 T-30 (3/PKG)
MA-9627 T-40 (3/PKG)
2" LENGTH
MA-9628 T-10 (2/PKG)
MA-9629 T-15 (2/PKG)
MA-9630 T-20 (2/PKG)
MA-9631 T-25 (2/PKG)
MA-9632 T-30 (2/PKG)
MA-9633 T-40 (2/PKG)

TAMPER-PROOF TORQ 1/4" HEX INSERT

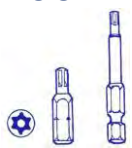

- 1" LENGTH**
MA-9634 T-10 (3/PKG)
MA-9635 T-15 (3/PKG)
MA-9636 T-20 (3/PKG)
MA-9637 T-25 (3/PKG)
MA-9638 T-30 (3/PKG)
MA-9639 T-40 (3/PKG)
2" LENGTH
MA-9640 T-10 (2/PKG)
MA-9641 T-15 (2/PKG)
MA-9642 T-20 (2/PKG)
MA-9643 T-25 (2/PKG)
MA-9644 T-30 (2/PKG)
MA-9645 T-40 (2/PKG)

MAGNETIC BIT HOLDER 1/4" HEX DRIVE

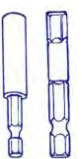

- 1" LENGTH - (1/PKG)**
MA-9662 2-1/2"
MA-9663 3"
MA-9664 1/4" X 1/4"
MA-9665 1/4" X 3/8"

ROBERTSON 1/4" HEX INSERT



- 1" LENGTH - (3/PKG)** **2" LENGTH - (2/PKG)**
MA-9650 1/16" **MA-9652** 1/8" **MA-9654** 1/16" **MA-9656** 1/8"
MA-9651 3/32" **MA-9653** 9/64" **MA-9655** 3/32" **MA-9657** 9/64"



FINGER PROTECTION PADS

NO SLIP GRIP SILICONE WEBBING

PADDED PALMS



FINGER PROTECTION PADS

NO SLIP GRIP SILICONE WEBBING

PADDED PALMS



BLACK/NEON GREEN

MA-GLVM MEDIUM

MA-GLVL LARGE

MA-GLVXL EXTRA LARGE

MA-GLVXXL EXTRA-EXTRA LARGE

MA-LINE WORK GLOVES

CAMOUFLAGE

MA-GLVL-C LARGE

MA-GLVXL-C EXTRA LARGE

MA-GLVXXL-C EXTRA-EXTRA LARGE



MA-13025
BLACK & RED TOOL BAG WITH RUBBER BASE

MADE OF STRONG 600D POLYESTER MATERIAL
RUBBER BOTTOM FOR EXTRA PROTECTION
INCLUDES SHOULDER STRAP AND HANDLE
10 INSIDE POCKETS - 14 POCKETS & 2 LOOPS SURROUNDING BAG OUTSIDE

DIMENSIONS: 16"L X 8"W X 13"H

MA-BP001
HEAVY DUTY BACK PACK WITH RUBBER BASE



MADE OF STRONG 600D POLYESTER MATERIAL
RUBBER BOTTOM FOR EXTRA PROTECTION

CARRYING HANDLE INCLUDES TWO STRAPS TACKED DOWN WITH RIVETS FOR REINFORCEMENT
INCLUDES ZIPPER LOCK FOR MAIN COMPARTMENT
SEPARATED TOOL WALL IN MAIN COMPARTMENT

DIMENSIONS: 33"L X 23"W X 47"H



CARRY ALL BLACK NYLON POUCH

MA-MC123

12"L X 6"W X 2"D

EXECUTIVE TOOL CASE

MA-5TCA



PLASTIC TOOL & TOTE CASES

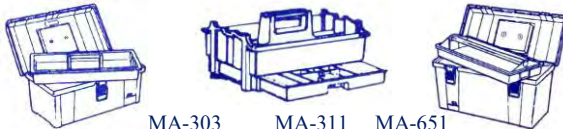

MA-303

MA-311

MA-651

MA-303 TOOL BOX WITH LIFT TRAY 15-3/8" X 7-3/4" X 4-1/4"

MA-311 TOTE MORE TOOL BOX 14-3/4" X 8-1/8" X 6-7/8"

MA-651 20" TOOL BOX-DEEP BOTTOM WITH LIFT TRAY 20-1/4" X 10-7/8" X 9-1/4"

METAL STORAGE DRAWERS

MA03375-2

21 COMPARTMENT DRAWER
13- 3/16" X 9-1/4" X 2"

MA03376-2

32 COMPARTMENT DRAWER
18" X 12" X 3"

MA03353-2

2 DRAWER SLIDE RACK FOR MA03375-2

MA03355-2

4 DRAWER SLIDE RACK FOR MA03375-2



MA03375-2



MA03353-2



MA03376-2

MA03355-2



(SLIDE RACKS DO NOT INCLUDE DRAWERS)

- (1) PLASTIC CARRYING CASE
- (4) EXTRA-STRENGTH NON-ASPRIN TABLETS
- (2) IBUPROFEN TABLETS
- (2) ASPRIN TABLETS
- (12) ANTESEPTIC CLEANSING WIPES (STING FREE)
- (8) ALCHOL CLEANSING PADS
- (4) ANTIBIOTIC OINTMENT PACKS
- (1) BURN RELIEF PACK
- (1) EMERGENCY BLANKET 38" X 60"
- (1) INSTANT COLD COMPRESS
- (5) BUTTERFLY WOUND CLOSURES
- (1) BURN RELIEF GEL PADS
- (1) FIRST AID TAPE ROLL 1/2" X 5 YDS.
- (1) FINGER SLPINT
- (50) PLASTIC BANDAGES 3/4" X 3"
- (10) FABRIC BANDAGES 3/4" X 3"
- (20) PLASTIC BANDAGES 1" X 3"

**ALL PURPOSE
FIRST AID KIT**

MA-FA134
200 PC FIRST AID KIT



- (20) JUNIOR ADHESIVE PLASTIC BANDAGES 3/8" X 1-1/2"
- (8) KNUCKLE FABRIC BANDAGES
- (8) FINGERTIP FABRIC BANDAGES
- (1) ELBOW & KNEE PLASTIC BANDAGE 2" X 4"
- (12) SPOT BANDAGES 7/8" X 7/8"
- (2) GAUZE DRESSING PADS 3" X 3"
- (10) GAUZE DRESSING PADS 2" X 2"
- (1) TRAUMA PAD 5"X 9"
- (1) STERILE EYE PAD
- (1) AMERICAN MEDICAL ASSOC. FIRST AID GUIDE
- (1) PLASTIC TWEEZERS
- (10) COTTON-TIPPED APPLICATORS 3"
- (2) LATEX-FREE EXAM QUALITY VINYL GLOVES

NON-SKID KNEE PADS

MA-992015

SUPER TOUGH BALLISTIC NYLON
BREATHABLE NEOPRENE STRAP
WITH DOUBLE CLOSUR SYSTEM
ANTI-COMPRESSION GEL FOR
ADDED COMFORT, DURABILITY
AND SHOCK ABSORPTION



**BOOT/SHOE
COVERS**



MA-73532 BLUE SHOE COVERS FITS
SIZES 6-12 (150 PAIRS PER CASE)

**COMBINATION
OIL PUMP**

MA-OCPI

FEATURES:

- SUCTION TRANSFER HOSE INCLUDED
- CONNECTS TO BOTTOM OF UNIT TO PUMP OIL FROM EQUIPMENT QUICKLY AND EFFICIENTLY
- REMOVE OIL FOR RECOVERY AND CONVERSION
- ADDS OIL TO EXISTING SYSTEMS



DOES NOT
OFFER
RESPIRATORY
PROTECTION



**NON-TOXIC
PARTICLE &
DUST MASK**

MA-7300
(50 MASKS PER BOX)

**BLUE NITRILE DISPOSABLE
POWDERED GLOVES**

100 GLOVES PER BOX

- MA-8646M** MEDIUM
- MA-8646L** LARGE
- MA-8646XL** EXTRA LARGE



The MA-Line Nitrile disposable gloves have superior softness and comfort. They are resistant to abrasion, punctures and chemical deterioration and are 100% Nitrile-hypoallergenic. They are cooler than latex because they relax and conform to your hand.

**GREASE, GREASE GUNS, FITTINGS,
TOOLS &
ACCESSORIES**



MA-11315

MA-111

MA-30200

A-11354

MA-30132

MA-11315 MULTI-PURPOSE GREASE 14OZ.
(10/CS) SOLD BY THE CASE - PRICE PER EACH

MA-11302 MULTI-PURPOSE GREASE 3.5OZ.
(2/BAG) SOLD BY THE PKG - PRICE PER PKG

MA-11354 WHITE LITHIUM GREASE 14OZ.
(10/CS) SOLD BY THE CASE PRICE PER EACH

MA-30132 MINI-GREASE GUN KIT

MA-30200 HEAVY DUTY GREASE GUN

MA-05028 COUPLER

MA-10214 12" GREASE HOSE

MA-10218 18" GREASE HOSE

GREY SMOKE CARTRIDGES



1A 30 SEC/4000 CU.FT. (12/PKG)

2B 1 MIN/8000 CU. FT. (12/PKG)

3C 3 MIN/40,000 CU. FT. (12/PKG)

WHITE SMOKE CARTRIDGES

MA-SC150CF 45 SEC/150 CU. FT. (10/PKG)

MA-SC600CF 90 SEC/600 CU. FT. (10/PKG)

MA-SC1200CF 4 MIN/1200 CU. FT. (5/PKG)

MA-SC5000CF 5 MIN/2500 CU. FT. (5/PKG)



ALL RUBBER

- MA-002RR** 2" X 2" X 3/8" 48/BOX
- MA-003RR** 3" X 3" X 3/8" 24/BOX
- MA-004RR** 4" X 4" X 3/8" 24/BOX
- MA-006RR** 6" X 6" X 3/8" 24/BOX
- MA-012RR** 12" X 12" X 3/8" 12/BOX
- MA-018RR** 18" X 18" X 3/8" 6/BOX

ANTI-VIBRATION PADS



NATURAL RUBBER

81 SQUARES PER SHEET PRICE PER SHEET

- MA-181834** 18" X 18" X 3/4" 6/BOX

CORK AND RUBBER

- MA-002CR** 2" X 2" X 7/8" 48/BOX
- MA-003CR** 3" X 3" X 7/8" 36/BOX
- MA-004CR** 4" X 4" X 7/8" 24/BOX
- MA-006CR** 6" X 6" X 7/8" 12/BOX
- MA-012CR** 12" X 12" X 7/8" 6/BOX
- MA-018CR** 18" X 18" X 7/8" 6/BOX

DEFROST THERMOSTATS
ML SERIES



- 32745** 45 TEMP (F) OPEN 45 CLOSE 25
- 32750** 50 TEMP (F) OPEN 50 CLOSE 30
- 32755** 55 TEMP (F) OPEN 55 CLOSE 35
- 32760** 60 TEMP (F) OPEN 60 CLOSE 40
- 32770** 70 TEMP (F) OPEN 70 CLOSE 50
- 32780** 80 TEMP (F) OPEN 80 CLOSE 30
- 32790** 90 TEMP (F) OPEN 90 CLOSE 35

- 33329** LOW PSI OPEN 5 RESET 20
- 33330** LOW PSI OPEN 10 RESET 20
- 33362** LOW PSI OPEN 20 RESET 50
- 33363** LOW PSI OPEN 20 RESET 80
- 33364** LOW PSI OPEN 40 RESET 90
- 33353** HIGH PSI OPEN 200 RESET 150
- 33354** HIGH PSI OPEN 250 RESET 150
- 33355** HIGH PSI OPEN 300 RESET 200
- 33356** HIGH PSI OPEN 350 RESET 250
- 33357** HIGH PSI OPEN 400 RESET 200
- 33358** HIGH PSI OPEN 400 RESET 300
- 33359** HIGH PSI OPEN 450 RESET 250

MINI PRESSURE SWITCHES



MA-TX402



MA-TX405



MA-TX501



MA-TX502



MA-TX779

MA-LINE CLASS 2 TRANSFORMERS

PART #	REPLACES	CONNECTION TYPE	PRIMARY VOLTAGE	SECONDARY VOLTAGE	OUTPUT RATING	MOUNTING STYLE
MA-TX202	620-202	NOT UL	120	24	20VA	PLUG-IN
MA-TX205	50351	WIRE LEAD	120	24	20VA	FOOT
MA-TX402	50333	WIRE LEAD	120/208/240	2.5, 12, 24	48VA	MULTI
MA-TX403	50302	WIRE LEAD	120	24	40VA	MULTI
MA-TX404	50303	WIRE LEAD	208/240	24	40VA	MULTI
MA-TX405	50352	WIRE LEAD	120	24	40VA	FOOT
MA-TX406	50353	WIRE LEAD	208/240	24	40VA	FOOT
MA-TX407	50304	WIRE LEAD	120/208/240	24	40VA	MULTI
MA-TX482	50354	WIRE LEAD	120/208/240	24	40VA	FOOT
MA-TX501	620-501	TERMINAL	120/208/240	28	50VA	UNIVERSAL CONNECTION WITH TERMINAL BOARD
MA-TX502	50314	WIRE LEAD	120/208/240	24	50VA	MULTI
MA-TX775	50320	WIRE LEAD	120/208/240/480 WITH FUSE	24	75VA	FOOT
MA-TX779	50321	WIRE LEAD	120/208/240/480 WITH CIRCUIT BREAKER	24	75VA	FOOT
MA-TX100	N/A	WIRE LEAD	120/208/240/480 WITH CIRCUIT BREAKER	24	100VA	FOOT

WORLD SOURCE VIBRATION ELIMINATORS (IMPORT)
STAINLESS STEEL VIBRATION ELIMINATORS WITH FEMALE COPPER ENDS



PART NUMBER	ACTUAL O.D. OF COPPER TUBING (IN.)	DIMENSION (INCHES)					MAX WORKING PRESSURE (PSIG.)	BURST PRESSURE (PSIG.)
		A (ID.)	B (+/- 1/8")	C (+/- 1/8")	D (+/- 1/4")	E (+/- 1/16")		
VE14OD	1/4	1/4	3/4	6-5/8	8-1/16	1/2	500	2500
VE38OD	3/8	3/8	13/16	6-15/16	8-9/16	1/2	500	2500
VE12OD	1/2	1/2	7/8	7-1/4	9	1/2	500	2500
VE58OD	5/8	5/8	15/16	8	9-7/8	11/16	500	2500
VE34OD	3/4	3/4	1-1/4	8-1/16	10-9/16	11/16	500	2500
VE78OD	7/8	7/8	1-7/16	9-1/8	12	13/16	500	2500
VE118OD	1-1/8	1-1/8	1-13/16	9-7/16	13-1/16	13/16	500	2500
VE138OD	1-3/8	1-3/8	2	11-1/2	15-9/16	7/8	500	2500
VE158OD	1-5/8	1-5/8	2-1/4	12-3/8	16-7/8	15/16	500	2500
VE218OD	2-1/8	2-1/8	2-3/4	15-3/16	20-5/8	15/16	390	1950
VE258OD	2-5/8	2-5/8	3-1/8	18-1/16	24-5/16	1-1/4	340	1700
VE318OD	3-1/8	3-1/8	3-7/16	20	26-15/16	1-1/2	300	1500
VE358OD	3-5/8	3-5/8	4-1/8	24	32-3/16	1-9/16	175	525
VE418OD	4-1/8	4-1/8	4-7/16	24	32-15/16	1-9/16	175	525

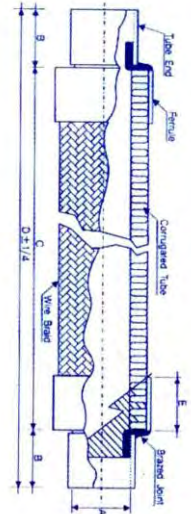

ANACONDA/UNIVERSAL VIBRATION ELIMINATORS

BRONZE WITH FEMALE ENDS PART NUMBER	TO FIT COPPER TUBE		FLEX. HOSE ID (IN.)	H(+/-) 1/4 (IN.)	DIMENSIONS			MAX. OPERATING PRESSURE PSI
	ACTUAL O.D. (IN.)	NOM. (IN.)			A MAX. (IN.)	B MAX. (IN.)	E(+/-)1/8 (IN.)	
1418FZ	1/4	1/8	1/4	7-1/2	9/16	5/8	1/2	700
5614FZ	3/8	1/4	5/16	8-1/4	11/16	3/4	5/8	700
3838FZ	1/2	3/8	3/8	9	3/4	7/8	3/4	500
1212FY	5/8	1/2	1/2	9-3/4	1	1-1/8	7/8	450
1258FY	3/4	5/8	1/2	10	1	1-1/8	1	450
3458FY	3/4	5/8	3/4	11-1/4	1-3/8	1-1/2	1-1/8	450
3434FY	7/8	3/4	3/4	11-1/2	1-3/8	1-1/2	1-1/4	450
1010FY	1-1/8	1	1	13	1-5/8	1-7/8	1-1/2	450
5454FY	1-3/8	1-1/4	1-1/4	14-3/4	2-1/8	2-1/4	1-5/8	500

STAINLESS STEEL WITH FEMALE ENDS PART NUMBER	TO FIT COPPER TUBE		FLEX. HOSE ID (IN.)	H(+/-) 1/4 (IN.)	DIMENSIONS			MAX. OPERATING PRESSURE PSI
	ACTUAL O.D. (IN.)	NOM. (IN.)			A MAX. (IN.)	B MAX. (IN.)	E(+/-) 1/8 (IN.)	
6464FS	1-5/8	1-1/2	1-1/2	17	2-1/4	2-3/8	2	400
2020FS	2-1/8	2	2	20	3-1/8	3-1/4	2-1/2	360
5252FS	2-5/8	2-1/2	2-1/2	24	3-3/4	3-7/8	3	300
3030FS	3-1/8	3	3	27	4-3/8	4-1/2	3-1/2	300
7272FS	3-5/8	3-1/2	3-1/2	23	4-5/8	4-15/16	3-3/16	150
4040FS	4-1/8	4	4	25	5-5/16	5-3/4	4-3/8	150
5050FS	5-1/8	5	5	27-1/2	6-1/4	---	5-1/2	150
6060FS	6-1/8	6	6	33	7-1/4	---	6-1/2	150
8080FS	8-1/8	8	8	42-1/2	9-1/2	---	7	150

WORLD SOURCE AND ANACONDA VIBRATION ELIMINATORS ARE SUITABLE FOR
R12 – R22 – R23 – R125
R134A – R401A – R401B
R402A – R402B – R404A
R407A – R407B – R407C
R408A – R409A – R410A
R410B – R412A – R502
R507 – R508 – R509



**COLD-CLIMATE
TIES**

ALL WEATHER APPLICATIONS
EXTENDED UV SUNLIGHT PROTECTION
FOR INSTALLATIONS DOWN TO -4°F/-20°C

EXTREME PERFORMANCE IN COLD WEATHER APPLICATIONS
CHILL OUT WITH COLD-CLIMATE TIES



PART NUMBER	LENGTH	TENSILE	WIDTH	THICKNESS	COLOR	QTY
MA-CCT7	7"	50#	0.18	0.054	UV BLACK	100
MA-CCT11	11"	50#	0.18	0.054	UV BLACK	100
MA-CCT14	14"	50#	0.18	0.054	UV BLACK	100
MA-CCT15	15"	**120	**0.298	**0.069	UV BLACK	100
MA-CCT7-K	7"	50#	0.18	0.054	UV BLACK	1000
MA-CCT11-K	11"	50#	0.18	0.054	UV BLACK	1000
MA-CCT14-K	14"	50#	0.18	0.054	UV BLACK	1000
MA-CCT15-K	15"	**120	**0.298	**0.069	UV BLACK	1000



**PLENUM RATED
WIRE TIES**

CONTINUOUS OPERATING TEMPERATURE:
MIN: -4°F MAX: 185°F/MIN: -40°C MAX: 85°C

TENSIL STRENGTH AT 73°F ASTM D-638:
12,000

UL FLAME RATING:
94V-2

GAMMA RADIATION RESISTANCE:
1 X 10RADS

*RoHS COMPLIANT *UL LISTED
MEETS UL2043 FOR USE IN PLENUM AIR HANDLING SPACES.

PART NUMBER	LENGTH	TENSILE	WIDTH	THICKNESS	COLOR	QTY
MA-PLT4	4"	18#	0.096	0.035	BURGUNDY	100
MA-PLT7	7"	50#	0.18	0.054	BURGUNDY	100
MA-PLT11	11"	50#	0.18	0.054	BURGUNDY	100
MA-PLT14	14"	50#	0.18	0.054	BURGUNDY	100
MA-PLT4-K	4"	18#	0.096	0.035	BURGUNDY	1000
MA-PLT7-K	7"	50#	0.18	0.054	BURGUNDY	1000
MA-PLT11-K	11"	50#	0.18	0.054	BURGUNDY	1000
MA-PLT14-K	14"	50#	0.18	0.054	BURGUNDY	1000

WIRE TIE MOUNTING PAD

MA03765-1
1" X 1" FLEXIBLE BASE
(10/PKG)



NATURAL WIRE TIES

PART #	LENGTH	BUNDLE DIA.	PKG.
MA02043-1	4" & 7-1/2"	ASSORT.	30
MA02044-1	11" & 14"	ASSORT.	30
MA02045-1	4" & 14"	ASSORT.	30
MA02046-1	4", 5-1/2" & 7-1/2"	ASSORT.	27
MA03171-1	4"	1/16" TO 3/4"	36
MA03172-2	4"	1/16" TO 3/4"	100
MA03174-1	5-1/2"	1/16" TO 1-1/2"	34
MA03175-2	5-1/2"	1/16" TO 1-1/2"	100
MA03177-1	7-1/2"	1/16" TO 1-3/4"	30
MA03178-2	7-1/2"	1/16" TO 1-3/4"	100
MA03180-1	11"	1/16" TO 3"	14
MA03181-2	11"	1/16" TO 3"	50
MA03183-1	14"	1/16" TO 4"	10
MA03184-2	14"	1/16" TO 4"	50
MA03185-1	17"	1/16" TO 4-1/2"	10
MA03188-2	17"	1/16" TO 4-1/2"	50



50# TENSILE STRENGTH
7-1/2"
11"
14"
17"

BLACK WIRE TIES

PART #	LENGTH	BUNDLE DIA.	PKG.
MA04702-2B	4"	1/16" TO 3/4"	100
MA04704-2B	5-1/2"	1/16" TO 1-1/2"	100
MA04706-2B	7-1/2"	1/16" TO 1-3/4"	100
MA04708-2B	11"	1/16" TO 3"	50
MA04710-2B	14"	1/16" TO 4"	50
MA04712-2B	17"	1/16" TO 4-1/2"	50

NATURAL SCREWDOWN WIRE TIES

PART #	LENGTH	BUNDLE DIA.	PKG.
MA03189-1	5-1/2"	1/16" TO 1-1/2"	13
MA03190-2	5-1/2"	1/16" TO 1-1/2"	100
MA03192-1	7-1/2"	1/16" TO 1-3/4"	10
MA03193-2	7-1/2"	1/16" TO 1-3/4"	100
MA03195-1	11"	1/16" TO 3"	7
MA03196-2	11"	1/16" TO 3"	50
MA03198-1	14"	1/16" TO 4"	6
MA03199-2	14"	1/16" TO 4"	50



BLACK SCREWDOWN WIRE TIES

PART #	LENGTH	BUNDLE DIA.	PKG.
MA04793-2B	7-1/2"	1/16" TO 1-3/4"	100
MA04796-2B	11"	1/16" TO 3"	50
MA04799-2B	14"	1/16" TO 4"	50

ASSORTED WIRE TIE JARS

MA-WTJ1 COLOR WIRE TIE
(600 PCS)

4" (50) RED & (50) BLACK
5-1/2" (50) WHITE & (50) BLACK
7-1/2" (50) WHITE, (50) BLACK,
(50) RED & (50) BLUE
11" (75) WHITE & (75) BLACK
14-1/2" (50) WHITE

MA-650N NATURAL WIRE TIES
(650 PCS)

4" (300), 7-1/2" (300) & 11" (50)

MA-650B BLACK WIRE TIES
(650 PCS)

4" (300), 7-1/2" (300) & 11" (50)



DUCT TIES



MA021120-2 24" NATURAL 175 LBS FOR 6" DUCT
MA036175-2 36" NATURAL 175 LBS FOR 11" DUCT
MA048175-2 48" NATURAL 175 LBS FOR 14" DUCT
MA021120-2B 24" BLACK 175 LBS FOR 6" DUCT
MA036175-2B 36" BLACK 175 LBS FOR 11" DUCT
MA048175-2B 48" BLACK 175 LBS FOR 14" DUCT

ASSORTED WIRE TIES

MA-LINE PACKS

MA-PAK-1

250 NATURAL WIRE TIES

4" (100), 7-1/2" (100) & 11" (50)

MA-PAK-2

300 NATURAL & BLACK WIRE TIES

NATURAL: 4" (50), 7-1/2" (50), 11" (50) & 14" (25)
BLACK: 7-1/2" (50), 11" (50) & 14" (25)

MA-PAK-3

450 BLACK WIRE TIES

5-1/2" (200), 7-1/2" (200) & 11" (50)

WIRE TIE GUNS



MA05007-2



MA05008-2

LIGHTWEIGHT PLASTIC FOR SMALL WIRE TIES

MA05008-2

HEAVY DUTY METAL FOR LARGE WIRE TIES

IDEAL FOR TENSIONING AND FOR CUTTING – DURABLE, LIGHTWEIGHT GUN HANDLES WIRE TIES UP TO 50LB LOOP STRENGTH. HEAVY DUTY GUN HANDLES 120-175 POUND.

VINYL GROMMETS

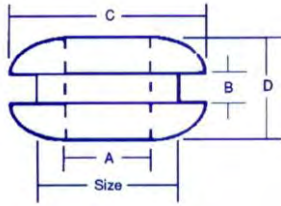

SIZE	A	B	C	D
1/4"	1/8"	1/16"	11/32"	3/16"
5/16"	3/16"	1/16"	7/16"	7/32"
3/8"	1/4"	1/16"	9/16"	1/4"
7/16"	5/16"	1/16"	5/8"	1/4"
1/2"	3/8"	1/16"	5/8"	1/4"
5/8"	1/2"	1/16"	13/16"	9/32"
21/32"	25/64"	1/8"	27/32"	3/8"
7/8"	5/8"	1/16"	1-1/8"	9/32"
1"	11/16"	1/16"	15/16"	3/8"

PART #	DESCRIPTION	PKG	PART #	DESCRIPTION	PKG
MA00151-1	1/4", 5/16", 3/8"	40	MA03168-1	7/8"	15
MA00152-1	7/16", 1/2", 5/8"	20	MA03169-1	1"	5
MA00153-1	21/32", 7/8", 1"	10	MA03161-2	1/4"	100
MA00154-1	1/4" THRU 1"	25	MA03162-2	5/16"	100
MA03161-1	1/4"	40	MA03163-2	3/8"	100
MA03162-1	5/16"	40	MA03164-2	7/16"	100
MA03163-1	3/8"	35	MA03165-2	1/2"	100
MA03164-1	7/16"	35	MA03166-2	5/8"	100
MA03165-1	1/2"	30	MA03167-2	21/32"	100
MA03166-1	5/8"	25	MA03168-2	7/8"	100
MA03167-1	21/32"	15	MA03169-2	1"	100

PART #	DESCRIPTION	PKG
MA00036-1		40
CLAMPS, GROMMETS & WIRE TIES		
MA00098-1	1/8", 3/8", 7/16"	30
MA00099-1	5/16", 3/8", 7/16"	25
MA00100-1	1/2", 9/16", 5/8"	25
MA00101-1	3/4", 1"	10
MA00102-1	1/8" THRU 1"	25

NYLON CABLE CLAMPS



1/8" THRU 9/16" =
3/8" WIDE

5/8" THRU 1" =
1/2" WIDE

PART #	DESCRIPTION	PKG	PART #	DESCRIPTION	PKG
MA03149-1	1/8"	35	MA03149-2	1/8"	100
MA03150-1	3/16"	35	MA03150-2	3/16"	100
MA03151-1	1/4"	25	MA03151-2	1/4"	100
MA03152-1	5/16"	25	MA03152-2	5/16"	100
MA03153-1	3/8"	25	MA03153-2	3/8"	100
MA03154-1	7/16"	15	MA03154-2	7/16"	100
MA03155-1	1/2"	15	MA03155-2	1/2"	100
MA03156-1	9/16"	15	MA03156-2	9/16"	100
MA03157-1	5/8"	15	MA03157-2	5/8"	100
MA03158-1	3/4"	10	MA03158-2	3/4"	100
MA03159-1	1"	10	MA03159-2	1"	100

ASSORTED TERMINAL RACK
MA-78TERM



PART #	DESCRIPTION	QTY/PKG.	QUANTITY
MA02898-2	SPECIAL DEVICE DISC. 16-14, 250 TAB	100	3
MA03011-2	BUTT SPLICE CON. 22-18	100	3
MA02596-2	BUTT SPLICE CON. 16-14	100	4
MA03012-2	BUTT SPLICE CON. 12-10	100	4
MA02598-2	QUICK DIS. FLARED VINYL INS. 16-14F, 250 TAB	100	4
MA03019-2	QUICK DIS. FLARED VINYL INS. 16-14F, 187 TAB	100	4
MA02619-2	QUICK DIS. FLARED VINYL INS. 12-10F, 250 TAB	100	4
MA03022-2	QUICK DIS. FLARED VINYL INS. 16-14M, 250 TAB	100	3
MA02621-2	RINGS FLARED VINYL INS. 16-14, 10 STUD	100	4
MA02622-2	RINGS FLARED VINYL INS. 12-10, 10 STUD	100	4
MA02978-2	SPADE FLARED VINYL INS. 16-14, 10 STUD	100	4
MA02982-2	SPADE FLARED VINYL INS. 12-10, 8 STUD	100	4
MA02597-2	SPADE FLARED VINYL INS. 16-14, 8 STUD	100	4
MA02911-2	SPECIAL DEVICE DISC. 16-14, 250 INS. TAB	100	3
MA03033-2	CLOSED END CONNECTORS 22-18, 5/8"	100	4
MA03034-2	CLOSED END CONNECTORS 12-10, 5/8"	100	4
MA02896-2	SPECIAL DEVICE DISC. 16-14, 250 TAB	100	3
MA02904-2	SPECIAL DEVICE DISC. 16-14, 250 TAB	100	4
MA03344-2	COMPRESSOR NON-INSULATED 12-8, 250 TAB	100	3
MA03471-2	QUICK DISC. FULLY INSULATED 16-14F, 250 TAB	100	4
MA03473-2	QUICK DISC. FULLY INSULATED 16-14M, 250 TAB	100	4
CR-RACK	COUNTER DISPLAY RACK WITH MA-LINE SIGN	1	1
CR-HOOKS	HOOKS FOR COUNTER DISPLAY RACK	1	21

BUTT SPLICE CONNECTORS

PART # RANGE PKG
INSULATED - FLARED - VINYL
UL/CSA -167°F(75°C) - 300V -
PVC/BRASS

MA02014-1	ASSORT	17
MA02521-1	16-14	20
MA02596-2	16-14	100
MA02522-1	12-10	15
MA03012-2	12-10	100
MA02591-1	22-18	20
MA03011-2	22-18	100

NON-INSULATED - UL/CSA - COPPER

MA02818-1	16-14	35
MA03791-2	16-14	100
MA02816-1	22-18	20
MA03790-2	22-18	100
MA02820-1	12-10	35
MA03792-2	12-10	100

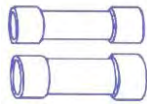

FLARED VINYL
INSULATED



NON-INSULATED

CLOSED END CONNECTORS

PART#	WIRE RANGE	DIM	PKG
MA02551-1	12-10	5/8"	10
MA03034-2	12-10	5/8"	100
MA02548-1	16-14	7/8"	10
MA03035-2	16-14	7/8"	100
MA02549-1	22-18	5/8"	15
MA03033-2	22-18	5/8"	100

UL/CSA
302°F (150°C)
ALUMINUM
SLEEVE

90 DEGREE DISCONNECT WITH SCREW

PART #	TAB	PKG
MA03775-1	.250	5
MA03775-2	.250	100



**SPECIAL DEVICE
IN-LINE SPLICES**

MA03063-1 IN-LINE 18-14
BLUE (8/PKG)

MA01066-1 T-TAP/MALE ASSORTMENT
KIT/250 TAB/BLUE (8/PKG)

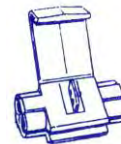

MA03063-1



MA01066-1

SPECIAL DEVICE DISCONNECTS

PART #	RANGE	TAB	PKG
MA02109-1	16-14	250 INSUL.	10
MA02911-2	16-14	250 INSUL.	100
MA02595-1	-	250	15
MA02898-2	-	250	100
MA02896-1	-	250	10
MA02896-2	-	250	100
MA02903-1	-	250	10
MA02904-2	-	250	100
MA02906-1	-	250	10
MA02907-2	-	250	100
MA03042-1	-	250	5
MA03042-2	-	250	100
MA03349-1	-	250/10STUD	10
MA03349-2	-	250/10STUD	100
MA01029-1	12-10	250	10
MA01029-2	12-10	250	100
MA01023-1	-	250	10
MA01023-2	-	250	100

MA02896-1 MA02906-1
MA02896-2 MA02907-2
MA02109-1 MA02903-1
MA02911-2 MA02904-2
MA01023-1 MA02595-1
MA01023-2 MA02898-2
MA03042-1 MA03349-1

**QUICK DISCONNECTS FLARED
 VINYL INSULATED**

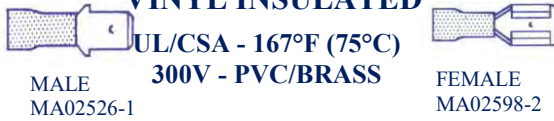

PART #	RANGE	TAB	PKG
MA02013-1	ASSORT	-	20
MA03028-1	16-14M	187	20
MA03029-2	16-14M	187	100
MA02526-1	16-14M	250	20
MA03022-2	16-14M	250	100
MA02590-1	12-10M	250	15
MA03023-2	12-10M	250	100
MA02587-1	22-18M	250	20
MA03018-1	16-14F	187	20
MA03019-2	16-14F	187	100
MA02588-1	16-14F	250	20
MA02598-2	16-14F	250	100
MA02589-1	12-10F	250	15
MA02619-2	12-10F	250	100
MA03015-1	22-18F	187	20
MA03016-2	22-18F	187	100
MA02586-1	22-18F	250	20
MA03013-2	22-18F	250	100

FLARED VINYL INSULATED RINGS



UL/CSA - 167°F (75°C)
 300V - PVC/BRASS

PART #	RANGE	STUD	PKG
MA02536-1	16-14	6	20
MA02951-2	16-14	6	100
MA02537-1	16-14	8	20
MA02620-2	16-14	8	100
MA02528-1	16-14	10	20
MA02621-2	16-14	10	100
MA02532-1	16-14	1/4	15
MA02952-2	16-14	1/4	100
MA02955-1	16-14	5/16	15
MA02955-2	16-14	5/16	100
MA02956-1	16-14	3/8	15
MA02960-1	12-10	6	15
MA02581-1	12-10	8	15
MA02962-2	12-10	8	100
MA02530-1	12-10	10	15
MA02622-2	12-10	10	100
MA02534-1	12-10	1/4	10
MA02623-2	12-10	1/4	100
MA02969-1	12-10	1/2	5
MA02969-2	12-10	1/2	100
MA02968-1	12-10	3/8	15
MA02968-2	12-10	3/8	100
MA02577-1	22-18	6	20
MA02939-2	22-18	6	100
MA02578-1	22-18	8	20
MA02940-2	22-18	8	100
MA02579-1	22-18	10	20
MA02942-2	22-18	10	100
MA02580-1	22-18	1/4	15
MA02944-2	22-18	1/4	100
MA02065-1	8	1/4	15
MA02065-2	8	1/4	100
MA02066-1	6	1/4	15
MA02066-2	6	1/4	100

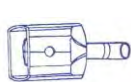

**QUICK DISCONNECTS
 FULLY INSULATED**

UL/CSA - 221°F (105°C) - 300V - NYLON/BRASS

PART #	RANGE	TAB	PKG
MA03466-1	16-14MF	250	10
MA03471-1	16-14F	250	10
MA03471-2	16-14F	250	100
MA03473-1	16-14M	250	10
MA03473-2	16-14M	250	100
MA03475-1	12-10F	250	10
MA03475-2	12-10F	250	100
MA03477-1	12-10M	250	10
MA03477-2	12-10M	250	100
MA03465-1	22-18MF	250	10
MA03467-1	22-18F	250	10
MA03467-2	22-18F	250	100
MA03469-1	22-18M	250	10
MA03469-2	22-18M	250	100



TYPE A

**SPADES-FLARED
 VINYL INSULATED**



TYPE B

PART #	RANGE	STUD	PKG	TYPE	PART #	RANGE	STUD	PKG	TYPE	PART #	RANGE	STUD	PKG	TYPE
MA01042-1	22-18	8	20	A	MA02585-1	16-14	6	20	B	MA02543-1	12-10	10	15	B
MA01042-2	22-18	8	100	A	MA02977-2	16-14	6	100	B	MA02983-2	12-10	10	100	B
MA01043-1	16-14	8	20	A	MA02544-1	16-14	8	20	B	MA02583-1	22-18	6	20	B
MA01043-2	16-14	8	100	A	MA02597-2	16-14	8	100	B	MA02971-2	22-18	6	100	B
MA01046-1	12-10	10	15	A	MA02541-1	16-14	10	20	B	MA02973-1	22-18	8	20	B
MA01046-2	12-10	10	100	A	MA02978-2	16-14	10	100	B	MA02974-2	22-18	8	100	B
					MA02980-1	12-10	6	15	B	MA02584-1	22-18	10	20	B
					MA02547-1	12-10	8	15	B	MA02975-2	22-18	10	100	B
					MA02982-2	12-10	8	100	B					

RINGS-SPADES-DISCONNECTS
NON-INSULATED



RING

DISCONNECTS

SPADE

PART #	RANGE	STUD	PKG	PART #	RANGE	STUD	PKG	PART #	RANGE	STUD	PKG
RINGS				SPADES				DISCONNECTS			
MA02707-2	22-10	6	100	MA02762-2	22-18	6	100	MA02821-1	22-18F	110	20
MA02724-2	16-14	6	100	MA02770-1	16-14	6	35	MA02822-2	22-18F	110	100
MA02726-1	16-14	8	35	MA02771-2	16-14	6	100	MA02823-1	22-18F	250	35
MA02727-2	16-14	8	100	MA02773-1	16-14	8	35	MA02824-2	22-18F	250	100
MA02729-1	16-14	10	35	MA02774-2	16-14	8	100	MA02825-1	16-14F	250	35
MA02729-2	16-14	10	100	MA02776-1	16-14	10	35	MA02826-2	16-14F	250	100
MA02744-1	12-10	8	25	MA02777-2	16-14	10	100	MA02827-1	12-10F	250	30
MA02745-2	12-10	8	100	MA02779-1	12-10	6	25	MA02828-2	12-10F	250	100
MA02746-1	12-10	10	25	MA02780-2	12-10	6	100	MA02830-1	22-18F	187	35
MA02747-2	12-10	10	100	MA02782-1	12-10	8	25	MA02833-1	16-14F	187	35
MA02749-1	12-10	1/4	20	MA02783-2	12-10	8	100	MA02834-2	16-14F	187	100
MA01123-1	8	10	5	MA02785-1	12-10	10	25	MA02837-2	22-18M	250	100
MA01124-1	8	1/4	5	MA02786-2	12-10	10	100	MA02839-1	16-14M	250	35
								MA02840-2	16-14M	250	100
								MA02842-1	12-10M	250	35
								MA02843-2	12-10M	250	100

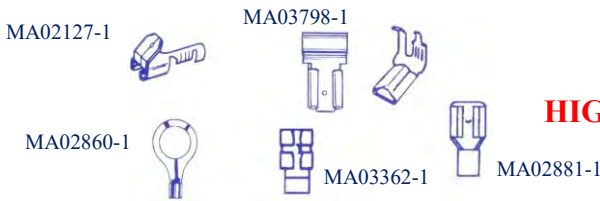

HIGH TEMPERATURE NON-INSULATED
SOLDERLESS TERMINALS

PART #	RANGE	STUD	PKG
MA02127-1	16-14	.250	4
MA02127-2	16-14	.250	100
RINGS			
MA03773-1	16-14	6	30
MA03780-2	16-14	6	100
MA02860-1	16-14	10	30
MA02861-2	16-14	10	100
MA03774-1	16-14	1/4	20
MA03781-2	16-14	1/4	100
MA02869-1	12-10	10	20
MA02870-2	12-10	10	100
MA02872-1	12-10	1/4	15
MA02873-2	12-10	1/4	100
MA03771-1	22-18	6	30
MA03778-2	22-18	6	100
MA03772-1	22-18	10	30
MA03779-2	22-18	10	100
MA02142-1	8	1/4	20
MA02142-2	8	1/4	100

PART #	RANGE	STUD	PKG
DISCONNECTS			
MA02875-1	16-14F	250	20
MA02876-2	16-14F	250	100
MA03362-1	16-14	250	20 FLAG
MA03363-2	16-14	250	100 FLAG
MA03776-1	16-14F	187	20
MA03782-2	16-14F	187	100
MA02881-1	12-10F	250	20
MA02882-2	12-10F	250	100
MA03798-1	12-10	250	20 FLAG
MA03798-2	12-10	250	100 FLAG
MA03783-2	22-18	187	100 FEMALE
MA03784-1	22-18	187	20 MALE
MA03784-2	22-18	187	100 MALE
SPADES			
MA03794-2	16-14	10	100
MA03785-1	18-14M	250	15
MA03785-2	18-14M	250	100
MA03793-1	22-10	10	25
MA03793-2	22-10	10	100

COMPRESSOR
NON-INSULATED

PART #	RANGE	TAB	PKG	TYPE
MA03360-1	20-14	187	10	A
MA03361-2	20-14	187	50	A
MA03343-1	12-8	250	5	B
MA03344-2	12-8	250	50	B
MA03344-3	12-8	250	100	B
MA01130-1	16-14	250	10	B
MA01130-2	16-14	250	100	B

FLAG DISCONNECT
NON-INSULATED

PART #	RANGE	TAB	PKG
MA02592-1	16-14F	250	30
MA02618-2	16-14F	250	100
MA02894-1	16-14F	187	20
MA02894-2	16-14F	187	100
MA03395-1	12-10F	250	15
MA03395-2	12-10F	250	100



18 ITEMS = 175 ASSORTED PIECES

- 10 pcs. Insulated Q/D: Female, Blue: 16-14
- 7 pcs. Insulated Q/D: Female, Yellow: 12-10
- 7 pcs. Insulated Rings: Yellow: 12-10, 1/4" Stud
- 7 pcs. Insulated Rings: Yellow: 12-10, 8 Stud
- 10 pcs. Insulated Rings: Blue: 16-14, 10 Stud
- 10 pcs. Insulated Rings: Blue: 16-14, 8 Stud
- 10 pcs. Insulated Q/D: Male, Blue: 16-14
- 11 pcs. Butt Connector: Red: 22-18
- 10 pcs. Butt Connector: Blue: 16-14
- 7 pcs. Butt Connector: Yellow: 12-10
- 10 pcs. Insulated Spade: Blue: 16-14, 10 Stud
- 10 pcs. Insulated Spade: Blue: 16-14, 8 Stud

175 ASSORTED PIECES CONT'D

- 16 pcs. Non-Insulated Flag: 16-14
- 16 pcs. Non-Insulated Piggy Back: 16-14
- 8 pcs. Non-Insulated Compressor Terminal: 16-14
- 15 pcs. Closed-End Connector: 1 6-14x8, 12-10x7
- 9 pcs. Wire Connector: Orange (4) Yellow (5)
- 3 pcs. Wire Connector: Red

**175 PIECE TERMINAL KIT
 (STORED IN PLASTIC BOX)**

MA02652-2

TO SERVICE A/C, REFRIGERATION, AND COOLING UNITS



21 ITEMS = 201 ASSORTED PIECES

- 20 pcs. Insulated Disconnect: 16-14F/.250 Tab
- 15 pcs. Insulated Disconnect: 12-10F/.250 Tab
- 5 pcs. Compressor Non-Insulated: 12-18/.250 Tab
- 10 pcs. Connectors and Adapters: .250 (2)M (1)F
- 10 pcs. Connectors and Adapters: .250 (1)M (1)F
- 10 pcs. Insulated Rings: 16-14, 10 Stud
- 10 pcs. Insulated Rings: 16-14, 8 Stud
- 10 pcs. Insulated Rings: 12-10, 1/4" Stud
- 10 pcs. Butt Connector: Blue: 16-14
- 10 pcs. Butt Connector: Yellow: 12-10
- 10 pcs. Butt Connector: Red: 22-18

201 ASSORTED PIECES CONT'D

- 10 pcs. Closed-End Connectors: 22-18
- 10 pcs. Closed-End Connectors: 12-10
- 5 pcs. Non-Insulated Flag Disconnects: 16-14F
- 10 pcs. Insulated Spade: 16-14F, 8 Stud
- 10 pcs. Insulated Disconnect: 16-14M/.250 Tab
- 10 pcs. Insulated Ring: 12-10, 8 Stud
- 10 pcs. Insulated Spade: 16-14F, 10 Stud
- 10 pcs. Wire Connector: Orange
- 5 pcs. Wire Connector: Yellow
- 1 pc. Crimping Tool

**201 PIECE DELUXE TERMINAL KIT
 (STORED IN A METAL BOX)**

MA02653-2

201 OF THE MOST POPULAR ITEMS TO SERVICE A/C, REFRIGERATION, AND COOLING UNITS

SMALL ASSORTMENT KITS - INSULATED



**ASSORTED RING &
 BUTT CONNECTORS**

- MA02012-1 (14/PKG.)**
 3PCS. 12-10 BUTT CONN.
 3PCS. 12-10 #10 STUD SPADES
 4PCS. 12-10 #10 STUD RINGS
 2PCS. 12-10 #8 STUD RINGS
 2PCS. 12-10 1/4" STUD RINGS

**ASSORTED
 BUTT CONNECTORS**

- MA02014-1 (17/PKG)**
 8PCS. 16-14, 6PCS. 22-10
 & 3PCS. 12-10



**ASSORTED RINGS, SPADES
 & CONNECTORS**

- MA02015-1 (20/PKG)**
 2PCS. EA. 22-18, 16-14 & 12-10 BUTT CONN.
 2PCS. EA. 12-10 & 16-14 #10 STUD SPADES
 2PCS. EA. 12-10 & 16-14 #10 STUD RINGS
 2PCS. 16-14 #6 STUD RINGS
 2PCS. 22-18 #10 STUD RINGS
 2PCS. 22-18 #6 STUD RINGS

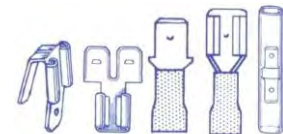

**ASSORTED QUICK
 DISCONNECTS**

- MA02013-1 (20/PKG)**
 2PCS. EA. 12-10F, 16-14F, 22-18F .250 TAB
 2PCS. EA. 12-10M, 16-14M, 22-18M .250 TAB
 2PCS. 3 WAY ADAPTOR .250 TAB
 2PCS. PIN TYPE MALE
 4PCS. .250 SPECIAL DEVICES



MA03754-2

MA03754-2 (60 PCS)
SPECIAL NUT KIT
6-32, 8-32, 10-24 & 1/4-20
MA03756-2 (90 PCS)
**NYLON INSERT
LOCK NUT KIT**
6-32, 8-32, 10-24, 10-32,
1/4-20 & 5/16-18



MA03756-2



MA03750-2

MA03750-2 (50 PCS)
SET SCREW KIT
6-32X1/4, 8-32X1/4, 8-32X3/4,
10-24X1/4, 10-32X1/4, 10-32X3/4,
1/4-20X3/8 & 5/16-18X3/8
MA03757-2 (60 PCS)
SHEET METAL SCREW KIT
8X1/2, 8X3/4, 10X1/2, 10X1



MA03757-2



MA03752-2

MA03752-2 (40 PCS)
**SOLDERLESS
TERMINAL KIT INSULATED**
MA03802-2 (24 PCS)
**SOLDERLESS LG. GAUGE
TERMINAL KIT
NON-INSULATED**



MA03802-2



**PLASTIC STORAGE
BOXES**

MA-3600

18 COMPARTMENT BOX

MA-3612

12 COMPARTMENT BOX



ANCHOR KITS



INCLUDES DRILL BIT 100 ANCHORS
& 100 SLOTTED PAN HEAD SCREWS

MA-8410 3/16" X 3/4", 6-8 SLOTTED
PAN HEAD SCREWS

MA-8411 1/4" X 1", 10-12 SLOTTED PAN HEAD SCREWS

MA-8412 5/16" X 1-1/2", 14-16 SLOTTED PAN HEAD SCREWS
INCLUDES 50 ANCHORS &
50 COMBINATION PAN HEAD SCREWS

MA-8414 8 X 1-1/4" PLASTIC

MA-8415 8 X 1-1/4" METAL



MA-LINE "MARK-IT"
TOUGH VINYL MARKERS
WITH ACRYLIC ADHESIVE.
SERVICE TEMP.
-50F TO 200F (-45C TO 90C)
DISPENSER PROTECTS
UNUSED LABELS

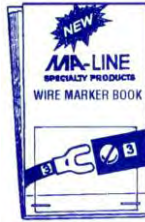

WIRE MARKER IDENTIFICATION TAPE DISPENSER/BOOKS

- MA02152-2** 10-PAGE WIRE MARKER BOOK
#1 THROUGH #45 (1/PKG)
- MA02153-2** 10-PAGE WIRE MARKER BOOK
A-Z, 0-15, +, - and / (1/PKG)
- MA02148-2** DISPENSER W/TAPE 0-9 (1/PKG)
- MA02149-2** REPLACEMENT ROLLS 0-4 (1/PKG)
- MA02150-2** REPLACEMENT ROLLS 5-9 (1/PKG)
- MA02151-2** REPLACEMENT ROLLS 0-9 (1/PKG)

TERMINAL BLOCKS & JUMPERS



- | | |
|--|--|
| MA-6182 DOUBLE ROW 4 TERMINAL
20AMP BLOCK 2.2" LONG | MA-6192 DOUBLE ROW 4 TERMINAL
30AMP BLOCK 3.2" LONG |
| MA-6183 DOUBLE ROW 6 TERMINAL
20AMP BLOCK 2.9" LONG | MA-6193 DOUBLE ROW 6 TERMINAL
30AMP BLOCK 4.3" LONG |
| MA-6184 DOUBLE ROW 8 TERMINAL
20AMP BLOCK 3.7" LONG | MA-6194 DOUBLE ROW 8 TERMINAL
30AMP BLOCK 5.5" LONG |
| MA-6185 DOUBLE ROW 10 TERMINAL
20AMP BLOCK 4.4" LONG | MA-6195 DOUBLE ROW 10 TERMINAL
30AMP BLOCK 6.6" LONG |
| MA-6186 DOUBLE ROW 12 TERMINAL
20AMP BLOCK 5.2" LONG | MA-6196 DOUBLE ROW 12 TERMINAL
30AMP BLOCK 7.7" LONG |
| MA-6187 DOUBLE ROW 14 TERMINAL
20AMP BLOCK 5.9" LONG | MA-6197 DOUBLE ROW 14 TERMINAL
30AMP BLOCK 8.8" LONG |
| MA-6188 JUMPER FOR 20AMP
TERMINAL BLOCK (10/PKG) | MA-6198 JUMPER FOR 30AMP
TERMINAL BLOCK (10/PKG) |

MA-6182 – MA-6187

UL RECOGNIZED FOR 20AMP
(250v COMMERCIAL EQUIP.)
FITS SAME SPACE AS A 15AMP STRIP
MAX WIRE SIZE 14 TERMINAL
WIDTH 7/8" SCREW SIZE 6

MA-6192 – MA-6197

UL RECOGNIZED FOR 30AMP
(800v COMMERCIAL EQUIP.)
MAX WIRE SIZE 12 TERMINAL WIDTH
1-5/16" SCREW SIZE 8

HEAT SHRINK TUBING

TUBING IS 4" IN
LENGTH

- MA00478-1** ASSORTED 3/16", 1/4" & 3/8" (8/PK)
- MA00479-1** ASSORTED 1/2", 3/4" & 1" (5/PK)
- MA00480-1** ASSORTED 1/16" THRU 1" (7/PK)
- MA03383-1** 1/8" (10/PK)
- MA03385-1** 3/16" (8/PK)
- MA03387-1** 1/4" (7/PK)
- MA03389-1** 3/8" (6/PK)
- MA03391-1** 1/2" (5/PK)
- MA03393-1** 3/4" (4/PK)
- MA03394-1** 1" (3/PK)





MA-8203

CIRCUIT AND VOLTAGE TESTERS

- MA-8201** COMBINATION CIRCUIT TESTER AND SCREWDRIVER FOR 80-250V AC/DC WITH POCKET CLIP
- MA-8202A** LOW VOLTAGE TESTER 5-50V AC/DC, TWIN LEAD CIRCUIT TESTER WITH ALLIGATOR CLIPS
- MA-8203** 4 WAY TESTER FOR AC/DC VOLTAGES 110, 220, 277 AND 440 WITH POCKET CLIP
- MA-8205** GFI RECEPTACLE TESTER



MA-8205



MA-8202A



MA-8201



VOLTAGE TESTER & LED FLASHLIGHT

24 TO 1000VAC

MA-49858A

VOLTAGE PROBE & CONTINUITY TESTER

MA-8206



VOLTAGE TESTER

80-300V AC/DC, 50-60HZ

MA-7321

SOLENOID VOLTAGE TESTER

AC: 120-240-480-600V
DC: 120-240-600V

MA-8207



ALLIGATOR AND BATTERY CLIPS



MA03090-1
MA03093-1
MA03096-2



MA02933-1
MA02936-1



MA03092-1

- MA02933-1** NON-INSULATED SMALL (8/PKG)
- MA02936-1** NON-INSULATED MEDIUM (6/PKG)
- MA03090-1** 2 BLACK & 2 RED INSULATED BOOTS- SMALL (4/PKG)
- MA03092-1** CABLE CLAMP STYLE CLIP – 2 BLACK AND 2 RED (4/PKG)
- MA03093-1** BLACK & RED INSULATED BOOTS – LARGE (4/PKG)
- MA03096-2** JUMBO BATTERY CLIPS WITH 1 BLACK AND 1 RED BOOT

TEST LEADS AND ADAPTORS



MA02987-2



MA02991-3



MA05031-2



MA-32831
MA-32832

- MA02987-2** 6" LENGTH (2/PKG) 1 BLACK AND 1 RED ADAPTORS
- MA02991-3** 14 AWG, 24" LONG LEADS
- MA05031-2** 18 AWG, 10EA. 18" LONG TEST LEADS
- MA-32831** 2' FEMALE CORD ADAPTER
- MA-32832** 6' MALE CORD ADAPTER

RELAY/OVERLOAD COMBINATION

MA-IC13
1/4 & 1/3 HP, 120V, 50/60HZ

MA-IC15
1/8, 1/6, 1/5 HP 120V, 50/60HZ

- FEATURES:**
- BUILT IN MOUNTING CLIP
- MOUNTS IN ANY POSITION
- PREWIRED FOR FAST AND SIMPLE INSTALLATION
- CAN BE USED WITH IN A CAPACITOR OR NON-CAPACITOR APPLICATION.



- ### COMPRESSOR LEADS
- MA02984-2** 8" COMPRESSOR LEADS
 - MA02984-3** 18" COMPRESSOR LEADS
 - MA02985-2** 8" COMPRESSOR LEADS WITH RINGS
 - MA02985-3** 18" COMPRESSOR LEADS WITH RINGS



- MA01018-1** (25/BAG)
- MA01018-2** (50/BAG)
- MA01018-3** (100/BAG)
- MA01018BX** (100/BOX)
- MA01018P** (500/TUB)

- GREY:** NO. 22 THRU 14 AWG
MIN: 1PC. #20 AWG & 1PC. #22 AWG
MAX: 2PCS. #16
- BLUE:** NO. 22 THRU 14 AWG
MIN: 1PC. #18 AWG & 1PC. #22 AWG
MAX: 3PCS. #16
- ORANGE:** NO. 22 THRU 14 AWG
MIN: 1PC. #18 AWG & 1 PC. #20 AWG
MAX: 3PCS. #16 AWG & 1PC. #18 AWG
- YELLOW:** NO. 18 THRU 10 AWG
MIN: 3PCS. #18 AWG
MAX: 3PCS. #12 AWG
- RED:** NO. 18 THRU 8 AWG
MIN: 2PCS. #14 AWG
MAX: 2PCS. #10 AWG & 2PCS. #12 AWG.

GREY

“TWIST ON” SPRING GRIP WIRE CONNECTOR

- | | | | |
|----------------------------|----------------------------|----------------------------|----------------------------|
| MA01019-1 (20/BAG) | MA01020-1 (15/BAG) | MA01021-1 (10/BAG) | MA01022-1 (5/BAG) |
| MA01019-2 (50/BAG) | MA01020-2 (50/BAG) | MA01021-2 (50/BAG) | MA01022-2 (50/BAG) |
| MA01019-3 (100/BAG) | MA01020-3 (100/BAG) | MA01021-3 (100/BAG) | MA01022-3 (100/BAG) |
| MA01019BX (100/BOX) | MA01020BX (100/BOX) | MA01021BX (100/BOX) | MA01022BX (100/BOX) |
| MA01019P (500/TUB) | MA01020P (250/TUB) | MA01021P (250/TUB) | MA01022P (100/TUB) |
| BLUE | ORANGE | YELLOW | RED |

WINGED WIRE CONNECTORS

- | | | | |
|---------------------------|---------------------------|----------------------------|----------------------------|
| MA10606-1 (5/BAG) | MA10608-1 (5/BAG) | MA10602-1 (15/BAG) | MA10604-1 (10/BAG) |
| MA10606-2 (50/BAG) | MA10608-2 (50/BAG) | MA10602-2 (100/BAG) | MA10604-2 (100/BAG) |
| MA10606BX (50/BOX) | MA10608BX (50/BOX) | MA10602BX (100/BOX) | MA10604BX (100/BOX) |
| GREY | BLUE | YELLOW | RED |



PORCELAIN WIRE CONNECTOR KIT

- MA-PWN46**
(15) SMALL
(25) MEDIUM
(6) LARGE

SMALL = 2X18GA, 3X18GA OR 4X20GA
MEDIUM = 3X18GA, 4X18GA OR 5X20GA
LARGE = 2X14GA, 5X18GA OR 6X20GA

MAX. TEMP. RATING - UP TO 1800F (982C)

PORCELAIN WIRE CONNECTOR

- | | | |
|-----------------------------------|------------------------------------|-----------------------------------|
| MA01164-1 SMALL (15/BAG) | MA01165-1 MEDIUM (10/BAG) | MA01166-1 LARGE (10/BAG) |
| MA01164C-2 SMALL (100/BAG) | MA01165C-2 MEDIUM (100/BAG) | MA01166C-2 LARGE (100/BAG) |



TAN WINGED WIRE CONNECTORS

IN A PLASTIC TUB WITH HANDLE
WIRE SIZE: 22-8

- MA04132-1** (25/BAG)
- MA04233-2** (120/TUB)



240 PIECES ASSORTED WIRE CONNECTORS
IN A PLASTIC TUB WITH HANDLE
MA06295P

ASSORTED WINGED WIRE CONNECTORS
IN A PLASTIC TUB WITH HANDLE

MA10610P



WIRE CONNECTOR ASSORTMENT

MA03751-2 (50 PCS)
BLUE, RED, YELLOW, ORANGE & A PLASTIC STORAGE BOX



SOFT WIRE CONNECTORS

SPECIAL DEVICES
SCOTCHLOCKS®

- | | |
|---------------------------|---------------------------|
| MA03075-1 (10/BAG) | MA03077-1 (5/BAG) |
| MA03076-2 (50/BAG) | MA03373-2 (25/BAG) |
| RED/YELLOW: 16-10/18-12 | BLUE/GREY: 12-6/14-8 |

UL 1015,
600V, 105C

STRANDED

**MOTOR
HOOK UP
WIRE**



PART #	AWG	FT/PKC	PART #	AWG	FT/PKC
<u>RED</u>			<u>RED</u>		
MA03217-2	18	35	MA03217-3	18	100
MA03218-2	16	20	MA03218-3	16	100
MA03219-2	14	15	MA03219-3	14	100
MA03220-2	12	12	MA03220-3	12	100
MA03221-2	10	8	MA03221-3	10	100
<u>BLACK</u>			<u>BLACK</u>		
MA03222-2	18	35	MA03222-3	18	100
MA03223-2	16	20	MA03223-3	16	100
MA03224-2	14	15	MA03224-3	14	100
MA03225-2	12	12	MA03225-3	12	100
MA03226-2	10	8	MA03226-3	10	100
<u>WHITE</u>			<u>WHITE</u>		
MA03227-2	18	35	MA03227-3	18	100
MA03228-2	16	20	MA03228-3	16	100
MA03229-2	14	15	MA03229-3	14	100
MA03230-2	12	12	MA03230-3	12	100
MA03231-2	10	8	MA03231-3	10	100
<u>GREEN</u>			<u>GREEN</u>		
MA03232-2	18	35	MA03232-3	18	100
MA03233-2	16	20	MA03233-3	16	100
MA03234-2	14	15	MA03234-3	14	100
MA03235-2	12	12	MA03235-3	12	100
MA03236-2	10	8	MA03236-3	10	100
<u>BLUE</u>			<u>BLUE</u>		
MA03237-2	18	35	MA03237-3	18	100
MA03238-2	16	20	MA03238-3	16	100
MA03239-2	14	15	MA03239-3	14	100
MA03240-2	12	12	MA03240-3	12	100
MA03241-2	10	8	MA03241-3	10	100

**HIGH TEMPERATURE GLASS BRAIDED
SILICONE/RANGE WIRE**

USED FOR MOTOR LEADS, TRANSFORMERS, APPLIANCES, ELECTRIC OR OTHER ELECTRICAL CIRCUITS WHERE A FLEXIBLE CONDUCTOR IS REQUIRED TO OPERATE UNDER HIGH TEMPERATURE CONDITIONS AND WHERE MOISTURE IS PRESENT.

400F AND 200C MAX. TEMPERATURE – 600 MAX. VOLTAGE
14 GAUGE UL 3071 AND 12 GAUGE UL STYLE 3074,
CSA TYPE SEW-2

**THREE STRANDED 12 & 14 GAUGE WIRE
RED, WHITE & BLACK**

PART #	LENGTH	PART #	LENGTH
<u>12 GAUGE</u>		<u>14 GAUGE</u>	
MA0512G	5'	MA0514G	5'
MA01012G	10'	MA01014G	10'
MA02512G	25'	MA02514G	25'
MA05012G	50'	MA05014G	50'

**THHN
(STRANDED OR SOLID)
WIRE**



PART	STRANDED	PART	SOLID
<u>BLACK</u>		<u>BLACK</u>	
MA-THHN8B	8 GAUGE	MA-THHNS-10B	10 GAUGE
MA-THHN10B	10 GAUGE	MA-THHNS-12B	12 GAUGE
MA-THHN12B	12 GAUGE	MA-THHNS-14B	14 GAUGE
MA-THHN14B	14 GAUGE	<u>RED</u>	
<u>RED</u>		MA-THHNS-10R	10 GAUGE
MA-THHN8R	8 GAUGE	MA-THHNS-12R	12 GAUGE
MA-THHN10R	10 GAUGE	MA-THHNS-14R	14 GAUGE
MA-THHN12R	12 GAUGE	<u>WHITE</u>	
MA-THHN14R	14 GAUGE	MA-THHNS-10W	10 GAUGE
<u>WHITE</u>		MA-THHNS-12W	12 GAUGE
MA-THHN8W	8 GAUGE	MA-THHNS-14W	14 GAUGE
MA-THHN10W	10 GAUGE	<u>GREEN</u>	
MA-THHN12W	12 GAUGE	MA-THHNS-10G	10 GAUGE
MA-THHN14W	14 GAUGE	MA-THHNS-12G	12 GAUGE
<u>GREEN</u>		MA-THHNS-14G	14 GAUGE
MA-THHN8G	8 GAUGE		
MA-THHN10G	10 GAUGE		
MA-THHN12G	12 GAUGE		
MA-THHN14G	14 GAUGE		

UL APPROVED
500' SPOOLS

USED FOR:
APPLIANCES
COIL LEADS
SWITCHBOARD PANELS
TRANSFORMERS
MOTOR LEADS

**3-STRANDED
CROSS-LINKED
POLYETHYLENE
RANGE WIRE**

250F AND 125C MAX. TEMPERATURE – 600 MAX. VOLTAGE
12 & 14 GAUGE UL TYPE 3173, CSA TYPE CL 1251/AWM
SINGLE WIRE – RED, BLACK & WHITE

PART #	LENGTH	GAUGE	PART #	LENGTH	GAUGE
MA0512P	5'	12	MA0514P	5'	14
MA01012P	10'	12	MA01014P	10'	14
MA02512P	25'	12	MA02514P	25'	14
MA05012P	50'	12	MA05014P	50'	14

SINGLE STRAND 12 GAUGE WIRE

PART #	LENGTH	PART #	LENGTH	PART #	LENGTH
<u>RED</u>		<u>BLACK</u>		<u>WHITE</u>	
MA0HT12R1	5'	MA0HT12B1	5'	MA0HT12W1	5'
MA0HT12R2	10'	MA0HT12B2	10'	MA0HT12W2	10'
MA0HT12R3	25'	MA0HT12B3	25'	MA0HT12W3	25'
MA0HT12R4	50'	MA0HT12B4	50'	MA0HT12W4	50'
MA0HT12R5	100'	MA0HT12B5	100'	MA0HT12W5	100'

SINGLE STRAND 14 GAUGE WIRE

PART #	LENGTH	PART #	LENGTH	PART #	LENGTH
<u>RED</u>		<u>BLACK</u>		<u>WHITE</u>	
MA0HT14R1	5'	MA0HT14B1	5'	MA0HT14W1	5'
MA0HT14R2	10'	MA0HT14B2	10'	MA0HT14W2	10'
MA0HT14R3	25'	MA0HT14B3	25'	MA0HT14W3	25'
MA0HT14R4	50'	MA0HT14B4	50'	MA0HT14W4	50'
MA0HT14R5	100'	MA0HT14B5	100'	MA0HT14W5	100'



GAS BALL VALVES

ALL MODELS HAVE AGA, UL AND CSA APPROVALS
LEVER HANDLE FORGED BRASS BALL VALVES. STANDARD PORT,
FULL PORT, 600 PSI, W.O.G, 150 PSI SATURATED STEAM.

- MA-73101** 1/2" OD X 1/2" FPT STRAIGHT (C)
- MA-73102** 5/8" OD FLARE X 3/4" FPT (C)
- MA-73105** 3/8" FPT X 3/8" FPT (D)
- MA-73103** 1/2" FPT X 1/2" FPT (D)
- MA-73104** 3/4" FPT X 3/4" FPT (D)
- MA-73106** 1" FPT X 1" FPT (D)
- MA-73107** 1-1/4" FPT X 1-1/4" FPT STANDARD PORT (B)
- MA-73108** 1-1/2" FPT X 1-1/2" FPT STANDARD PORT (B)
- MA-73109** 2" FPT X 2" FPT STANDARD PORT (B)
- MA-73110** 1-1/4" FPT X 1-1/4" FPT FULL PORT (A)
- MA-73111** 1-1/2" FPT X 1-1/2" FPT FULL PORT (A)
- MA-73112** 2" FPT X 2" FPT FULL PORT (A)

- 3/8" I.D. TUBE - 1/2" FIP X 1/2" MIP
- MA-CSSD54-12** 12" LONG
 - MA-CSSD54-18** 18" LONG
 - MA-CSSD54-24** 24" LONG
 - MA-CSSD54-36** 36" LONG
 - MA-CSSD54-48** 48" LONG
 - MA-CSSD54-60** 60" LONG
 - MA-CSSD54-72** 72" LONG

- 1/2" I.D. TUBE - 3/4" FIP X 3/4" MIP
- MA-CSSC21-12** 12" LONG
 - MA-CSSC21-18** 18" LONG
 - MA-CSSC21-24** 24" LONG
 - MA-CSSC21-36** 36" LONG
 - MA-CSSC21-48** 48" LONG
 - MA-CSSC21-60** 60" LONG
 - MA-CSSC21-72** 72" LONG

- 1/2" I.D. TUBE - 1/2" FIP X 1/2" MIP
- MA-CSSC54-12** 12" LONG
 - MA-CSSC54-18** 18" LONG
 - MA-CSSC54-24** 24" LONG
 - MA-CSSC54-36** 36" LONG
 - MA-CSSC54-48** 48" LONG
 - MA-CSSC54-60** 60" LONG
 - MA-CSSC54-72** 72" LONG

**FLEXIBLE GAS CONNECTORS
AGA & CGA CERTIFIED**



COATED STAINLESS STEEL

INDOOR/OUTDOOR GAS CONNECTOR FOR RESIDENTIAL AND COMMERCIAL GAS APPLIANCE

TEMPERATURE RANGE: -40F TO 150F

CSA APPROVED

POLYMER COATING RESISTS SEA SALT, UV RAYS, HARSH CHEMICAL RESIDUE AND BUILDING PRODUCTS SUCH AS SOLDER FLUX, MURIATIC ACID, AMMONIA AND CHLORINE.

HEATING SYSTEM BOILER GAUGES



- MA-10344** 1/2" NPT 0-75 PSI BOTTOM MOUNT, 4" SQUARE 60F TO 260F (20C TO 120C)
- MA-10345** 1/2" NPT 0-75 PSI BACK MOUNT, 4" SQUARE 60F TO 260F (20C TO 120C)
- MA-10346** 1/2" NPT 0-200 PSI BOTTOM MOUNT, 4" SQUARE 60F TO 260F (20C TO 120C)
- MA-10347** 1/2" NPT 0-200 PSI BACK MOUNT, 4" SQUARE 60F TO 260F (20C TO 120C)
- MA-10348** 1/2" NPT 0-55 PSI BOTTOM MOUNT, 3" ROUND 0-125FT. H2O, 70F TO 250F(20C TO 120C), 2" STEM
- MA-10349** 1/2" NPT 0-75 PSI BOTTOM MOUNT, 3" ROUND 0-170FT. H2O, 70F TO 320F(20C TO 120C), 3/4" STEM
- MA-10350** 1/4" NPT 0-75 PSI BACK MOUNT, 2-1/2" ROUND 60F TO 320F(20C TO 120C)

PROTECTIVE BOOT COVERS



- MA-49091** 2-1/2" RED **MA-49191** 3-1/8" RED
- MA-49092** 2-1/2" BLUE **MA-49192** 3-1/8" BLUE
- MA-49090** 2-1/2" SET **MA-49193** 3-1/8" SET

3/4" PRESSURE TEST GAUGE

- MA-17255** 0-15#
- MA-17256** 0-30#
- MA-17257** 0-100#



SANDCLOTH & PADS



- MA-04625** ABRASIVE PADS (10/BOX)
- MA-90303** 1-1/2" X 10YRDS. SAND CLOTH
- MA-90304** 1-1/2" X 25YRDS. SAND CLOTH
- MA-90502** 1-1/2" X 5YRDS. OPEN MESH
- MA-90503** 1-1/2" X 10YRDS. OPEN MESH



REFRIGERANT RECOVERY CYLINDERS ARE EQUIPPED WITH A LIQUID/VAPOR "Y" VALVE AND 3/4" OPENING.

OXYGEN TANKS

- T 002** 20 CU. FT.
- T 003** 40 CU. FT.
- T 032** 55 CU. FT.
- T 080** 80 CU. FT.
- T 125OX** 125 CU. FT.

NITROGEN TANKS

- T 027** 20 CU. FT.
- T 005** 40 CU. FT.
- T 076** 55 CU. FT.
- T 085** 80 CU. FT.
- T 125N** 125 CU. FT.

ACETYLENE TANKS

- T 019** MC TANK
- T 018** B TANK

ALL TANKS ARE MADE OF STEEL & SHIPPED EMPTY

REFRIGERANT RECOVERY CYLINDERS

- MA-400RC30** 30# FOR R410A
- MA-400RC50** 50# FOR R410A
- MA-400RC123** 123# FOR R410A

CO2 TANK

- T 0210** 5# REINSPECTED
- T 0220** 10# REINSPECTED
- T 0230** 15# REINSPECTED
- T 0240** 20# REINSPECTED

CO2 TANKS ARE USED, REINSPECTED & INCLUDES NEW VALVES

Y-VALVE FOR 30# AND 50# RECOVERY TANK MA-563211

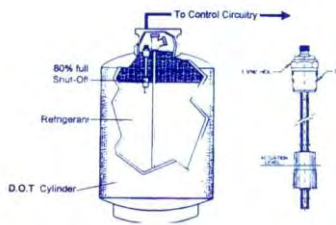
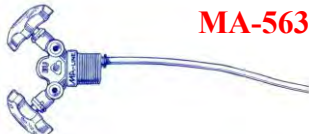

REFRIGERANT CYLINDER LIQUID LEVEL SWITCH

MA-128500

DESIGNED FOR 30# & 50# WORTHINGTON AND MANCHESTER CYLINDERS ONLY.

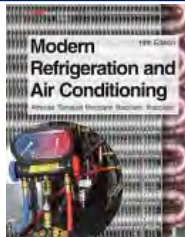

MODERN REFRIGERATION & A/C BOOK

LATEST EDITION IN HARD COVER

MA-340-5

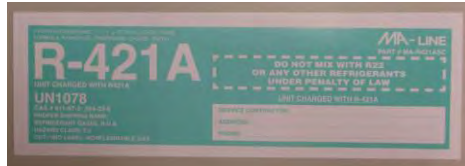

SERVICE CONTRACTOR REFRIGERANT LABELS

A MUST FOR EVERY SERVICE CONTRACTOR WHO FIELD-SERVICES APPLIANCES AND REFRIGERATION

5 PACK

MA-SDF1SC

SAFE FOR DISPOSAL

MA-RECTSC

EVACUATION TAG

MA-R407CSC

R407C-LIGHT BROWN

MA-R421ASC

R421A-GREEN YELLOW

REFRIGERANT LABELS

ADD -50 AFTER THE PART NUMBER TO ORDER A PACKAGE OF 50

10 PACK

- MA-SR11** OSHA ORANGE
- MA-SR12** BLACK
- MA-SR22** OSHA SAFETY GREEN
- MA-SR113** DARK PURPLE
- MA-SR114** BLUE
- MA-SR134A** LIGHT BLUE
- MA-SR401A** CORAL
- MA-SR401B** DULL ALUMINUM
- MA-SR402A** BRASS
- MA-SR402B** ERIN GREEN
- MA-SR404A** CITRUS ORANGE
- MA-SR406A** OSHA BLUE
- MA-SR408A** MEDIUM PURPLE

10 PACK

- MA-SR409A** DESERT BEIGE
- MA-SR410A** BURGUNDY
- MA-SR417A** GREEN
- MA-SR422B** MEDIUM BLUE
- MA-SR422D** (PANTONE) BLUE
- MA-SR438A** BLUE JAY
- MA-SR500** OSHA SAFETY YELLOW
- MA-SR502** VIOLET
- MA-SR507** TEAL BLUE
- MA-SHCFC123** CHROME ALUMINUM
- MA-SAB1** ALKYL BENZENE
- MA-SMO1** MINERAL OIL
- MA-SPA1** PAG OIL
- MA-SPO1** POLYOL ESTER



**HAND HELD
SCALE &
TAPE
MEASURE**

MA-HS50

2-1/2" DIAL
0-50LBS IN 1/LB INCREMENTS
LIGHTWEIGHT

**CRANKCASE
UL HEATERS CSA**

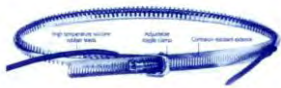

- MA-CH100** 240V, 50WATT
MIN. 30-3/16" MAX. 37"
- MA-CH101** 240V, 54WATT
MIN. 27-1/16" MAX. 34-1/4"
- MA-CH101-1** 208V, 54WATT
MIN. 27-1/16" MAX. 34-1/4"
- MA-CH101-2** 120V, 54WATT
MIN. 27-1/16" MAX. 34-1/4"
- MA-CH101-3** 480V, 54WATT
MIN. 27-1/16" MAX. 34-1/4"
- MA-CH102** 240V, 60WATT
MIN. 25-3/4" MAX. 32-9/16"
- MA-CH102-1** 208V, 60WATT
MIN. 25-3/4" MAX. 32-9/16"
- MA-CH102-2** 120V, 60WATT
MIN. 25-3/4" MAX. 32-9/16"
- MA-CH103** 240V, 45WATT
MIN. 24-3/4" MAX. 31-9/16"
- MA-CH103-2** 120V, 45WATT
MIN. 24-3/4" MAX. 31-9/16"
- MA-CH135** 240V, 45WATT
MIN. 28-3/16" MAX. 35-5/8"

WATER
HEATER PANS

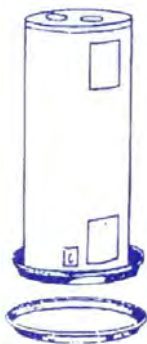

- MA-WHP22**
20" - 22" OD DIA.
- MA-WHP24**
22" - 24" OD DIA.
- MA-WHP26**
24" - 26" OD DIA.
- MA-WHP28**
26" - 28" OD DIA.
- MA-WHP32**
30" - 32" OD DIA.



**MA-LINE
DIGITAL
SCALE**

CAPACITY: 0-260LBS

MA-49052B
SCALE

MA-49052AUS
AUSTRALIAN
POWER CORD

MA-49052EPC
EUROPEAN
POWER CORD

99% ACCURACY - GRADUATION .001 OZ. (0.05KG) -
PLATFORM SIZE: 10" X 10" WITH RUBBER PAD -
POWER SUPPLY 110V, 60HZ/220V, 50HZ - AC POWER
ADAPTOR INCLUDED - (1) 9V BATTERY INCLUDED -
MEASURES LBS, OZ. & KGS

SCALES NOT LEGAL FOR TENDER



DIAL
0 TO 250 LBS.

MA-8250A

1 LB.
INCREMENTS



**250# MECHANICAL PLATFORM
SCALE**

**CONDENSATE
PANS**

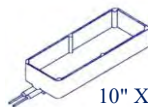

10" X 4" X 2-7/8"

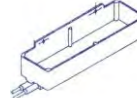

10" X 4-1/2" X 3-3/8"

- MA-CP35-120** 38OZ. CAPACITY, 160W, 120V
- MA-CP35-240** 38OZ. CAPACITY, 160W, 220V

Made of die-cast aluminum, the MA-Line Condensate Evaporator Pan eliminates floor drains. The pan is self-standing and all terminals are covered with moisture proof rubber. The evaporation rate is 8 oz. per hour at 72°F room temperature. The units heating element is sealed in 1/4" bundyweld tubing.

DRAIN PANS

Hot Water Heater Pans, made from tough, durable plastic. Easy to install and will not leak. Rustproof, one piece construction includes a 1" drain fitting.

Washing Machine Pans, fits under washing machine to protect floors and carpet from water overflow. Easy to install and includes a 1" drain fitting.

**HAND HELD
DIGITAL
SCALE**



MA-49051

LBS/KGS SWITCH
0-50LBS
AUTO SHUT OFF IN 2 MIN.
ACCURACY ±2%
INCLUDES 9V BATTERY

REFRACTOMETERS



- MA-REF700** OIL
- MA-REF401F** GLYCOL (F)
- MA-REF401C** GYLCOL (C)

-This handheld refractometer, **MA-REF700**, is easy to use and accurately measures the mineral oil in a polyolester (POE) lubricant.

SPECIFICATIONS: Range 1.435-1.520nD (with 3 scales)

-The **MA-REF401F**, measures the freezing point of ethylene or propylene glycol. The two Fahrenheit non-linear scales cover -60F to 32F for ethylene glycol and propylene glycol. The resolution of the temperature scale is 10F.

-The Celsius reading, **MA-REF401C** is also available.

**UNIVERSAL DRAIN
HEATER**

MA-32950

REFRIGERATION DRAIN HEATER
PREVENTS DRAIN TUBE ICING &
PLUGGING
CAN BE USED ON ALL MODELS AND
MAKES OF REFRIGERATORS

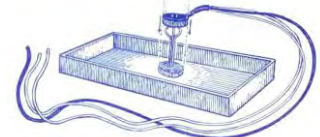

WASHING
MACHINE PAN

MA-WP1
29" - 27" ID DIM.

AUXILIARY
CONDENSATE PANS:

MA-CP1
28-3/4" X 33-3/4"

MA-CP2
17" X 39-3/4"

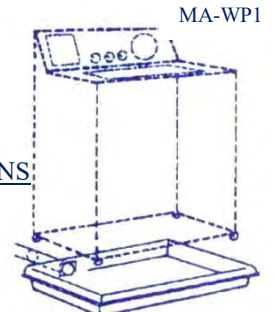

PLASTIC "Y" STRAINERS



"Y" Strainer especially designed for removing sediment in small flow applications. Typical uses include: beverage dispensing, beverage cooling, vending machines, power humidifiers and ice machines. FDA approved, 125lbs. corrosion free 100 mesh screen plug which is easily removed for cleaning.

MA-S14 1/4" FPT **MA-S38** 3/8" FPT

DELRIN SLEEVE AND BRASS INSERT

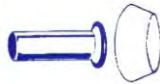

MA-DS4 1/4" DELRIN SLEEVE FOR 1/4" OD PLASTIC TUBING (25/PKG)
MA-DS6 3/8" DELRIN SLEEVE FOR 3/8" OD PLASTIC TUBING (25/PKG)
MA-BI4 1/4" BRASS INSERT 1/4" OD PLASTIC TUBING (25/PKG)
MA-BI6 3/8" BRASS INSERT FOR 3/8" OD PLASTIC TUBING (25/PKG)

HEAT GUN AND HEAT GUN KIT



MA02525-2
HEAT GUN ONLY
MA02525-3
HEAT GUN KIT
INCLUDES: HEAT GUN, SCRAPER, 3 ASSORTED SCRAPPING STYLES & 4 ASSORTED BLOWER NOZZLES
MA02525-EUKIT
EUROPEAN HEAT GUN KIT
SAME AS ABOVE WITH EUROPEAN CONTINENTAL PLUG

THREADED ROD, NUTS & WASHERS



THREADED ROD, PLAIN STEEL

MA-TR14 1/4" X 6' - 20
MA-TR516 5/16" X 6' - 18
MA-TR38 3/8" X 6' - 16
MA-TR12 1/2" X 6' - 13

NUTS AND WASHERS ARE 10/PKG AND PRICE PER PKG.

STEEL BRIGHT ZINC PLATED HEX NUTS FOR THREADED ROD

MA-N14 1/4" - 20
MA-N516 5/16" - 18
MA-N38 3/8" - 16
MA-N12 1/2" - 13

STEEL BRIGHT ZINC PLATED USS FLAT WASHERS FOR THREADED ROD

MA-W14 1/4"
MA-W516 5/16"
MA-W38 3/8"
MA-W12 1/2"



ICEMAKER & HUMIDIFIER HOOK-UP KIT



MA-VIMK3 SELF PIERCING SADDLE VALVE MEETS NSF REQUIREMENTS
MA-VIMK2 SELF-TAPPING SADDLE VALVE - CLAMP KIT - DOES NOT MEET NSF REQUIREMENTS
MA-IMK1 HUMIDIFIER KIT - INCLUDES SELF PIERCING SADDLE VALVE, 25' OF 1/4" OD POLYETHYLENE TUBING.

COPPER ICE MAKER AND HUMIDIFIER HOOK-UP KIT



MA-CIMK2
COPPER ICE MAKER

Meets NSF Requirements. Copper Tube Kit comes complete with 24' of copper tube and self tapping saddle valve, 1/4" x 1/8" compression x MIP connector, 1/4" compression union, 1/4" x 1/8" compression x MIP Elbow. Self-tapping valve installs on copper tube lines from 3/8" OD to 1-1/8" OD. No drilling required. Stainless steel pins prevent plug-ups and contamination.

FLAME SHIELDS



MA-1500 1500F (850C)
MA-2300 2300F (1260C)

CARBON MONOXIDE DETECTOR

MA-HU1

HOW DO I TEST? Remove from the sealed pack only when ready to use. If CO is present, the spot will turn gray or black. The spot will turn back to its original color when the air is clear of CO. If spot darkens after several months, replace the CO detector. Replace once per heating season. The shelf life in an unopen package is 3 years.

HOW FAST DOES IT WORK?
(Based on 60% Relative Humidity)

CONCENTRATION	REACTION TIME
100ppm (.010%)	15-45 minutes
200ppm (.020%)	4-15 minutes
400ppm (.040%)	2-4 minutes
600ppm (.060%)	1-2 minutes

NOTE:
Reaction time is slightly faster when damp and slightly slower when dry. Even the slightest gray color indicates a dangerous carbon monoxide level.



PHONE: 1-800-956-8220
PHONE: 1-847-956-8200

MA-LINE 2018 CATALOG
www.ma-line.com

FAX: 1-800-336-8291
FAX: 1-847-956-8237



EXPANDING POLYURETHANE FOAM SEALANT CLOSED CELL FOAM

- MA-1-12X** SINGLE COMPONENT 12OZ. (12/CS)
 - MA-11-12X** TWO COMPONENT 12OZ. (12/CS)
- SOLD PER CASE/PRICE PER PIECE

The MA-Line Seal Foam is a single component polyurethane foam used as an insulating sealant. Create a durable air tight seal that will minimize air infiltration, outdoor noise, pest infiltration, and the transfers of odors. When applied it reduces the risk of damage from condensation, moisture and ice buildup. It reduces air conditioning and heating cost because it provides an excellent R-Value. MA-Line Seal Foam can provide greater sealing properties compared to other types or styles of sealants. Unlike caulks and other style sealants, MA-Line Seal Foam assumes the shape of cavity and forms an air tight seal. Does not shrink and will retain sealant properties for many years to come. Product is a UL classified sealant #13655 and Ashrea 90-75 listed.

The two component polyurethane foam is similar to the single component foam, but acts much faster, expands more, and cures much faster. Great for spraying overhead, as it adheres very readily to duct board and sheet metal. Each package provides 12 linear board feet or 1 cubic foot of foam. Ozone friendly closed cell product contains no UREA formaldehyde, sets up in 45 seconds and cures within 5 minutes.



MA-101
MA-101 EZ THRUST CAULK GUN

CAULKING GUNS ALL STEEL



MA-102
MA-102 HEAVY DUTY DELUXE CAULK GUN

SILICONE CAULK AND HIGH TEMP. SILICONE CAULK



- MA-SSC-CK** CLEAR CAULK (12/CS) SOLD PER CASE PRICE PER PIECE
- MA-SSG-CK** GRAY CAULK (12/CS)
- MA-SSW-CK** WHITE CAULK (12/CS)
- MA-HTSS-R** RED HIGH TEMPERATURE CAULK (12/CS)

MA-Line Silicone Caulk is waterproof and weatherproof, FDA approved, permanently flexible, -60F to 450F, insulates and resealable. It meets FDA/USDA requirements for use in establishments operating under Federal Meat and Poultry Inspection Program. CFR 177.2600

MA-Line High Temperature Silicone Caulk is waterproof and weatherproof, FDA approved, permanently flexible, -84F to 500F, insulates thermally and electrically. Resealable. It meets FDA/USDA requirements for use in establishments operating under Federal Meat and Poultry Inspection Program. CFR 177.2600

FORMULATED TO PERFORM AT TEMPERATURES RANGING FROM -84F TO 500F (-65C TO 260C) FOR CONTINUOUS OPERATION AND TO 600F FOR INTERMITTENT EXPOSURE.



BLACK FLASHING

- MA-BFC** 12.8 OZ CARTRIDGE (12/CS)
- MA-BF1** 1GALLON CAN (4/CS)

ALL WEATHER-NEVER HARDENS
MEETS FEDERAL SPECIFICATIONS #SS-C-153C
SOLD PER CASE/PRICE PER EACH

MASTERFLASH

- MA-14050** 1/4" - 2" FITS 4-1/2" X 4-1/2" BASE
- MA-14051** 1-1/4" - 3" FITS 6" X 6" BASE
- MA-14052** 1/4" - 4" FITS 8" X 8" BASE
- MA-14053** 3" - 6" FITS 10" X 10" BASE
- MA-14054** 4" - 7" FITS 11" X 11" BASE
- MA-14055** 5" - 9" FITS 12" X 12" BASE
- MA-14056** 6" - 11" FITS 14" X 14" BASE
- MA-14057** 7" - 13" FITS 17" X 17" BASE



NO-CAULK ROOF FLASHINGS

- MA-11830** 1/2"-3/4"-1" SOLAR GALVANIZED BASE
- MA-11840** 1-1/4"-1-1/2" NON-CAULK GALVANIZED BASE
- MA-11853** 2" GALVANIZED BASE
- MA-11866** 3" GALVANIZED BASE
- MA-11879** 4" GALVANIZED BASE
- MA-14012** 2" ALL-FLEXIBLE, RUBBER BASE
- MA-14025** 2-1/2" ALL-FLEXIBLE, RUBBER BASE



This exclusive one-piece construction insures a positive leakproof installation every time. The specially formulated elastomeric collar allows the vent stack plenty of room for expansion and contraction. Not designed for hot-mopped or built up roofs. The All-Flexible flashings (MA-14012 & MA-14025) are manufactured from a specially formulated elastomer material which is extremely flexible and durable. Also allows room for the vent stack to expand and contract without disrupting the seal between pipe and flashing collar.

FURNACE CEMENT

- MA-HT1** 1 GAL. (4/CS)
 - MA-HT64** 64OZ. (6CS)
- ASBESTOS FREE, GRAY, HIGH HEAT CEMENT
TEMPERATURE RATING: 0F TO 3000F
SOLD PER CASE/PRICE PER EACH



REGULAR CEMENT FOR PVC PIPE AND FITTINGS

- MA-31012** 4 OZ. CAN (24/CS)
- MA-31013** 8 OZ. CAN (24/CS)
- MA-31014** 16 OZ. CAN (24/CS)
- MA-31015** 32 OZ. CAN (12/CS)

ALL PURPOSE CEMENT FOR ABS, PVC, CPVC

- MA-30818** 4 OZ. CAN (24/CS)
- MA-30821** 8 OZ. CAN (24/CS)
- MA-30834** 16 OZ. CAN (24/CS)
- MA-30847** 32 OZ. CAN (12/CS)

ALL WEATHER PVC CEMENT

- MA-31132** 16 OZ. CAN (24/CS)
- MA-31133** 32 OZ. CAN (12/CS)



PVC CEMENT

SOLD PER CASE
PRICE PER PIECE

ALL PURPOSE CEMENT: Heavy bodied clear cement for use on ABS, PVS, PVC, or CPVC pipe & fittings. Flows freely & provides a thick layer of cement on the pipe. Exceeds ASTM D2564, D2846, D-2235 and F-493. Application temperature 40F to 100F.

REGULAR CLEAR CEMENT: For PVC pipe and fittings, up to 4" SCH 40 & up to 2" for SCH 80 potable water pressure pipe, gas conduit, drain waste & vent pipe. Application temperature 40F to 100F.

CLEAR ALL WEATHER PVC CEMENT: For PVC pipe, good in all types of weather.

PIPE JOINT COMPOUND WITH TEFLON
SOLD PER CASE PRICE PER PIECE

- MA-31229** 1 FL.OZ. TUBE (12/CS)
- MA-31230** 4 FL.OZ. WITH BRUSH TOP (12/CS)
- MA-31231** 8 FL.OZ. WITH BRUSH TOP (12/CS)

A white, non-hardening, non-separating Teflon paste seals all threaded connections against leakage for internal pressure. Withstands 10,000 psi at -100F to 600F and formulated for use on water steam, natural and LP gas, oil, caustics, or dilute acid lines. May be used with PVC, CPVC, ABS, Cyclocac, Polypropylene, iron, steel or copper threads. **Do not use on oxygen, fluorine, or molten metal lines.**



REINFORCED FOAM TAPE

- MA-FT1A** (12/CASE)
- 1/8" X 2" X 30'

FEATURES:
ADHERES FIRMLY TO ALL METALS, PREVENTS CONDENSATION AND DRIPPING – CAN BE USED ON HOT OR COLD PIPES – WORKS WELL AROUND VALVES AND PIPES
SOLD PER CASE PRICE PER EACH

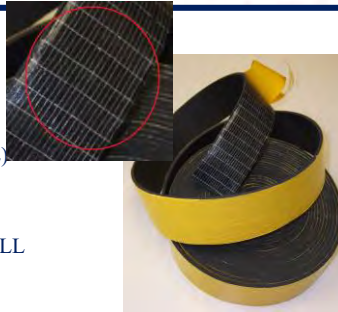

CORK TAPE

- MA-CT1** (12/CASE)
- 1/8" X 2" X 30'

FEATURES:
ADHERES FIRMLY TO ALL METALS, PREVENTS CONDENSATION AND DRIPPING – CAN BE USED ON HOT OR COLD PIPES
SOLD PER CASE PRICE PER EACH



TEFLON THREAD SEAL TAPE

- MA-C950** (48/CASE)
- 1/2" X 520"
- MA-C950-4** (4/PKG)
- 1/2" X 520"

SOLD PER PIECE/PRICE PER PIECE
ORDER 48 & GET A DISPLAY BOX FREE

FEATURES:
MA-LINE OFFERS MORE VALUE WITH OUR TEFLON BRAND, HIGH QUALITY SEAL TAPE.



ALUMINUM FOIL TAPE

- MA-322-2** (24/CASE)
- 2" X 50 YARDS
- MA-322-3** (16/CASE)
- 3" X 50 YARDS

FEATURES:
DESIGNED FOR TAPING JOINTS AND SEAMS TO KEEP OUT MOISTURE AND VAPOR ON FOIL JACKETING INSULATION
TEMPERATURE RANGE: 32F TO 302F (0C TO 150C)



PIPE JOINT COMPOUND

- MA-31226** 1 FL.OZ. TUBE (12/CS)
- MA-31227** 4 FL.OZ. BRUSH TOP (12/CS)
- MA-31228** 8 FL.OZ. BRUSH TOP (12/CS)

A fast set non-hardening paste which lubricates and seals threaded joints. Non-toxic and may be used on water, natural gas, steam and air lines. It's perfect for applying gaskets to flanges.



SOLD PER CASE
PRICE PER
PIECE

CONDENSATE PVC TRAPS



- MA-12535** 1/2" PVC P-TRAP
- MA-12537** 3/4" PVC P-TRAP
- MA-12545** 1/2" PVC R-TRAP
- MA-12547** 3/4" PVC R-TRAP
- MA-12548** 3/4" PVC J-TRAP

DUCT TAPE

2" X 60 YARDS (24/CASE)

- MA-398** SILVER
- MA-398BL** BLACK

SOLD PER CASE PRICE PER PIECE

FEATURES:
INDUSTRIAL GRADE –
8 MIL THICKNESS – ADHESIVE NATURAL RUBBER



MA-LINE ELECTRICAL TAPE

- MA-C6408**
- 3/4" X 60' (10/PKG)
- MA03364-2**
- 3/4" X 60' (3/PKG)

SOLD PER PIECE
PRICE PER
PIECE

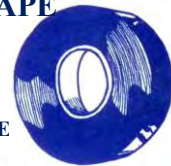

3M PREMIUM ELECTRICAL TAPI & VINYL COLOR CODING TAPE



SOLD PER CASE
PRICE PER
PIECE

- MA-C6433** SUPER 33+ BLACK/7 MIL THICKNESS
- MA-C6488** SUPER 88+ BLACK/8.5 MIL THICKNESS
- MA-C6435G** GRAY/7 MIL THICKNESS
- MA-C6435B** BLUE/7 MIL THICKNESS
- MA-C6435O** ORANGE/7 MIL THICKNESS
- MA-C6435R** RED/7 MIL THICKNESS
- MA-C6435W** WHITE/7 MIL THICKNESS
- MA-C6435Y** YELLOW/7 MIL THICKNESS
- MA-C6435GN** GREEN/7 MIL THICKNESS
- MA-C6435BR** BROWN/7 MIL THICKNESS

MADE IN USA – UL & CSA LISTED –
3/4" X 66' – UV RESISTANT
10 ROLLS PER CARTON



DIMENSIONS:
 18" X 33.5" X 24"
MATERIAL:
 ZINC COATED STEEL
FINISH:
 POWDER COATING
NOT TO EXCEED
450LBS.

MINI SPLIT CONDENSING BRACKET

MA-SB35

- (4) ANCHORING BOLT SCREWS
- (4) ANTI-VIBRATION PAD

BUILT IN LEVEL

FOR ACCURATE & EASY INSTALLATION



AC MOUNTING BRACKETS

MA-ACB36 (A)36" (B)16" (C) 31"

MA-ACB42 (A)42" (B)16" (C) 36"

MA-ACB48 (A)48" (B)18" (C) 38"

INCLUDES: 4 BOLTS, 4 ANCHORS AND 4 WASHERS

MAX. LOAD: 550 POUNDS

FINISH: POWDER COATING

ROD STEEL: 2.78MM THICKNESS AND 3.8CM WIDTH



MOTOR MOUNTING BRACKET

INCLUDES:
 GROMMETS AND EYELETS

MA-FM50 5"

MA-FM55 5.5"

For use with direct Drive Blower Motors



Mounting Accessories

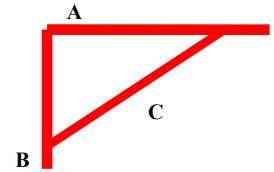

MOTOR MOUNTING BRACKET

INCLUDES:
 GROMMETS AND EYELETS

MA-FM554A 5-5/8"
(4 LEGS)

For use with direct Drive Blower Motors

MOUNTING BRACKETS
 INCLUDES: BRACKET, SLEEVES, STEEL SCREWS, & RUBBER GROMMETS

MA60042 5" ID -42 FRAME

MA60048 5.5"-48 FRAME



CONDENSER FAN RAIN SHIELD

MA61000 1/2"ID X 6.88"OD

MA61056 5/8"ID X 6.88"OD

MA80105 1/2"ID X 7.00"OD

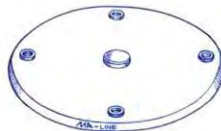

LUG MOUNTING BRACKETS

MA80293
 FOR 5.5" MOTORS



RUBBER GROMMET KIT

MA60049K

Used for 3/4" slots
 Screws & sleeves included

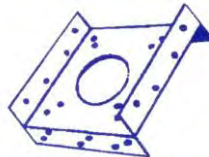

RHEEM MOUNTING BRACKET
MA60306K

Replaces cables used to mount motors on Rheem Condensing units



MOUNTING BRACKET

MA68004

Adjustable bracket for unit bearing motors.



**FAN BLADE PITCH
GAUGE
MA-PG1**



**PLASTIC REPLACEMENT
VENT HOOD FAN BLADES**

DIRECT REPLACEMENT FOR DUCTED AND
NON-DUCTED VENT HOODS

MA-CW665

6-5/8" DIAMETER, CW ROTATION, PITCH 12,
SHAFT SIZE 7/32", 5 BLADES

**V-BELTS
MADE TO PERFORM**

3L FHP V-BELTS 3/8" TOP WIDTH 7/32" THICK
4L (A) V-BELTS 1/2" TOP WIDTH 11/32" THICK
5L (B) V-BELTS 21/32" TOP WIDTH 13/16" THICK



PART #	OUTSIDE LENGTH	PART #	OUTSIDE LENGTH
MA3L310	31	MA4L230	23
MA3L320	32	MA4L240	24
MA3L330	33	MA4L250	25
MA3L340	34	MA4L260	26
MA3L350	35	MA4L270	27
MA3L360	36	MA4L280	28
MA3L370	37	MA4L290	29
MA3L380	38	MA4L300	30
MA3L390	39	MA4L310	31
MA3L400	40	MA4L320	32
MA3L410	41	MA4L330	33
MA3L420	42	MA4L340	34
MA3L430	43	MA4L350	35
MA3L440	44	MA4L360	36
MA3L450	45	MA4L370	37
MA3L460	46	MA4L380	38
MA3L470	47	MA4L390	39
MA3L480	48	MA4L400	40
		MA4L410	41
MA4L170	17	MA4L420	42
MA4L180	18	MA4L430	43
MA4L190	19	MA4L440	44
MA4L200	20	MA4L450	45
MA4L210	21	MA4L460	46
MA4L220	22	MA4L470	47

**LIGHT WEIGHT, GENERAL
PURPOSE REPLACEMENT
PLASTIC FAN BLADES**



Our 4 and 5 blade general purpose replacement fan blades have diameters ranging from 3" to 8". They are available for 1/8", 3/16", 1/4" & 5/16" shaft sizes. The rotation is identified by color. White is CW (clockwise) rotation and grey is for CCW (counter clockwise) rotation. All are with integral hub.

PART#	ROTATION	PITCH	SHAFT SIZE	#OF BLADES	DIA. INCHES
MA-CW300	CW	32	1/8"	4	3
MA-CW301	CW	32	3/16"	4	3
MA-CW401	CW	27	1/8"	5	4
MA-CCW403	CCW	27	1/8"	5	4
MA-CCW404	CCW	27	3/16"	5	4
MA-CW406	CW	35	1/8"	4	4
MA-CW501	CW	22	3/16"	5	5
MA-CW502	CW	22	1/4"	5	5
MA-CW503	CW	22	5/16"	5	5
MA-CCW505	CCW	22	1/4"	5	5
MA-CW601	CW	26	3/16"	4	6
MA-CCW605	CCW	24	1/4"	4	6
MA-CCW606	CCW	24	5/16"	4	6
MA-CW650	CW	24	3/16"	5	6-1/2
MA-CW652	CW	24	5/16"	5	6-1/2
MA-CW701	CW	30	1/4"	5	7
MA-CCW703	CCW	25	1/4"	5	7
MA-CW801	CW	38	1/4"	5	8
MA-CW802	CW	38	5/16"	5	8

PART #	OUTSIDE LENGTH	PART #	OUTSIDE LENGTH	PART #	OUTSIDE LENGTH
MA4L480	48	MA4L720	72	MA5L510	51
MA4L490	49			MA5L520	52
MA4L500	50	MA5L290	29	MA5L530	53
MA4L510	51	MA5L300	30	MA5L540	54
MA4L520	52	MA5L310	31	MA5L550	55
MA4L530	53	MA5L320	32	MA5L560	56
MA4L540	54	MA5L330	33	MA5L570	57
MA4L550	55	MA5L340	34	MA5L580	58
MA4L560	56	MA5L350	35	MA5L590	59
MA4L570	57	MA5L360	36	MA5L600	60
MA4L580	58	MA5L370	37	MA5L610	61
MA4L590	59	MA5L380	38	MA5L620	62
MA4L600	60	MA5L390	39	MA5L630	63
MA4L610	61	MA5L400	40	MA5L640	64
MA4L620	62	MA5L410	41	MA5L650	65
MA4L630	63	MA5L420	42	MA5L660	66
MA4L640	64	MA5L430	43	MA5L670	67
MA4L650	65	MA5L440	44	MA5L680	68
MA4L660	66	MA5L450	45	MA5L690	69
MA4L670	67	MA5L460	46	MA5L700	70
MA4L680	68	MA5L470	47	MA5L710	71
MA4L690	69	MA5L480	48	MA5L720	72
MA4L700	70	MA5L490	49		
MA4L710	71	MA5L500	50		

LOW PROFILE STYLE

INCLUDES:
SOLID BASE & RING BASE



MA-BTGDK CLEAR PLASTIC
MA-BTGDB BRONZE PLASTIC
MA-F336 UNIVERSAL KEY

INSIDE DIMENSIONS:
DUAL SOLID BASE:
4-1/4"H x 7-5/8"W x 2-1/8"D
DUAL RING BASE:
4-1/8"H x 7-1/16"W x 2-1/4"D

THERMOSTAT COVERS

DELUXE SERIES

INCLUDES:
SOLID BASE & RING BASE

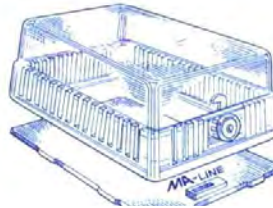

MA-BTGRK CLEAR PLASTIC
MA-F336 UNIVERSAL KEY

INSIDE DIMENSIONS:
SOLID BASE:
6-3/8"H x 3-1/2"W x 3"D
RING BASE:
6-3/8"H x 3-1/2"W x 3-1/4"D
The Deluxe Series is ideal for horizontal and vertical standard size wall thermostats.

SMALL & COMPACT

INCLUDES:
SOLID BASE

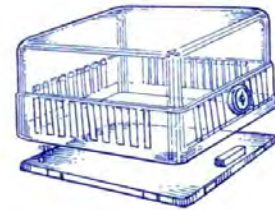

MA-BTGEK CLEAR PLASTIC
MA-F336 UNIVERSAL KEY

INSIDE DIMENSIONS:
SOLID BASE:
3-1/2"H x 3-7/8"W x 2-1/2"D

MEDIUM SIZE

MA-BTGM
INCLUDES:
SOLID & RING BASE



MA-BTGM
CLEAR PLASTIC
MA-F336
UNIVERSAL KEY

INSIDE DIMENSIONS:
SOLID BASE:
4-3/8"H x 5-1/4"W x 3"D
RING BASE:
4-5/8"H x 5-1/4"W x 3-1/4"D

UNIVERSAL SERIES

MA-BTGUK2

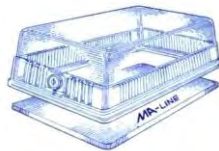

MA-BTGM
MA-BTGUM



MA-BTGUK2 CLEAR PLASTIC
INCLUDES A **RING** AND **SOLID** BASE
MA-BTGM BEIGE, METAL
INCLUDES **SOLID** BASE
MA-BTGUM BEIGE, METAL
INCLUDES **RING** BASE
MA-F336 UNIVERSAL KEY

PLASTIC INSIDE DIMENSIONS:
SOLID BASE: 8-1/4"H x 5-3/8"W x 3-1/2"D
RING BASE: 8-1/8"H x 4-5/8"W x 3-5/8"D

METAL INSIDE DIMENSIONS:
SOLID BASE: 7-1/4"H x 5-3/8"W x 3-1/2"D
RING BASE: 6-3/4"H x 4-1/4"W x 3-9/16"D

TAMPER PROOF SERIES

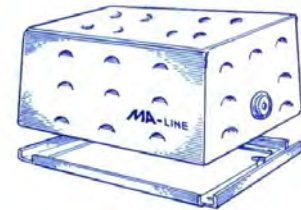

MA-BTG54VL BEIGE,
METAL, SOLID BASE
MA-BTG54VLW BEIGE,
METAL, RING BASE
MA-F336 UNIVERSAL KEY

INSIDE DIMENSIONS:
SOLID BASE:
6-1/4"H x 4-3/4"W x 3"D
RING BASE:
6"H x 3-13/16"W x 3-1/8"D

The Tamper Proof Series is strong and completely tamper proof. This strong thermostat cover can be mounted horizontal or vertical.

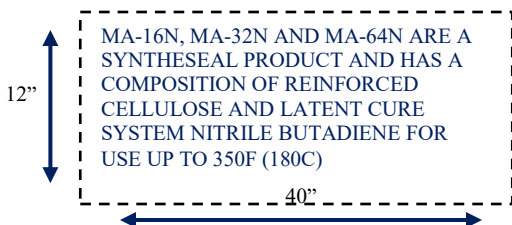

GASKET MATERIAL

MA-16N 1/16" NON ASBESTOS
MA-32N 1/32" NON ASBESTOS
MA-64N 1/64" NON ASBESTOS
MA-16RR 1/16" NON ASBESTOS
TEMP. -20F TO 120F, RED RUBBER
24" X 36" SMOOTH FINISH



RUBBER STRAPS

The "EPDM Rubber Tie Down" rubber is oil, ozone and chemical resistant. It will not fade in ultra violet light and can be used in temperatures ranging from 20°F to 120°F.

- MA-1109** 10" MAX.SAFE STRETCH 15"
- MA-1115** 15" MAX.SAFE STRETCH 22"
- MA-1122** 20" MAX.SAFE STRETCH 32"
- MA-1131** 31" MAX.SAFE STRETCH 46"
- MA-1141** 41" MAX.SAFE STRETCH 62"
- MA-76110** ASSORTED RUBBER STRAPS
(2) 10", (3) 15", (3) 20", & (2) 31"

NYLON STRAPS

- MA-S30** 30"
- MA-S60** 60"
- MA-S144** 144"
- MA-RS300**

15" RATCHETING TIE DOWN STRAP



SHOP WIPES

MA-SW70C-6
6/CTN SOLD BY CASE
PRICE PER EACH

75 TOWELS PER CONTAINER – NO NEED FOR WATER – SAFE FOR THE SKIN – DRIES FAST



MA-2WK
SPRAY PATTERNS
CONE, JET, FAN,
FLAT, FLOW,
CENTER, SHOWER,
SOAKER & MIST
**INSULATED
SPRAY
NOZZLES**

- MA-572A**
6 SPRAY PATTERNS
SOAKER, SHOWER,
CONE, FLAT,
MIST AND JET
- MA-W455**
HOSE WASHERS
(10/PK)



COLOR: YELLOW

TENSILE
STRENGTH:
1/4" DIA. 1250 LBS.
3/8" DIA. 2700 LBS.



POLYPROPYLENE ROPE

- MA-0360** 1/4" X 50'
- MA-0361** 1/4" X 100'
- MA-0362** 3/8" X 50'
- MA-0363** 3/8" X 100'

This 100% twisted 3 strand monofilament polypropylene has twice the strength of manila rope. Resistant to rot, abrasion, petroleum products, marine growth and most chemicals. It floats.

5/8" ID FLEXOGEN GREY GARDEN HOSE

- MA-GH25** 25' LONG
- MA-GH50** 50' LONG



SHOP TOWELS



- MA-33350** BLUE KIMTEX TOWELS, 180 PER BOX
- MA-33570** BLUE KIMTEX TOWELS, 100 PER BOX
- MA-34790** TERI-WIPES, 125 PER BOX
- MA-41300** WORKHORSE HEAVY DUTY, 150 PER BOX
- MA-XL80-5** COTTON SHOP TOWEL (RAGS) 5 PER BAG
- MA-XL80-25** COTTON SHOP TOWEL (RAGS) 25 PER BAG

30" LONG CONDENSER CLEANING TOOL

MA-0230



CHEMICAL RESISTANT 3 PINT HAND PUMP SPRAYER

MA-SP41501



TRIGGER
MAY BE
LOCKED
FOR
CONTINUOUS
SPRAY

CHEMICAL RESISTANT PUMP STYLE SPRAYER

- MA-SP44**
1 GALLON
- MA-SP45**
2 GALLON
- MA-SP46**
3 GALLON



TRIGGER SPAYERS

- MA-8016** PINT (12/CASE)
- MA-8032** QUART (12/CASE)

Multi-purpose trigger Sprayer for almost any cleaning solution. An adjustable nozzle for a fine mist or solid stream. Has a durable polymer head and polyethylene bottle.



UNIT COOLERS FOR REFRIGERATED CABINETS



MEDIUM TEMPERATURE AIR DEFROST

PART#	BTU/HR 10° T.D.	DIMENSIONS			CFM	FAN DIA.	115V MTR AMPS	CONNECTIONS			APPROX. SHIP WT.
		H.	W.	D.				INLET	SUCTION	DRAIN	
MALS-55A	550	4-1/2	10	14	125	5	.65	3/8 OD	1/2 OD	1/2 OD	9
MALS-105A	1050	4-1/2	16-1/2	14	125	5	.65	3/8 OD	1/2 OD	1/2 OD	12
MALS-135A	1350	4-1/2	20-1/2	14	225	(2)5	1.3	3/8 OD	1/2 OD	1/2 OD	16
MALS-190A	1700	4-1/2	24	14-1/2	225	(2)5	1.3	3/8 OD	1/2 OD	1/2 OD	21
MALS-240A	2400	6-5/8	24	16-1/2	300	8	.73	3/8 OD	1/2 OD	1/2 OD	24
MALS-320A	3000	4-1/2	40	14-1/2	350	(3)5	1.95	3/8 OD	1/2 OD	1/2 OD	33
MALS-410A	4300	4-1/2	53.4	14-1/2	475	(4)5	2.6	3/8 OD	1/2 OD	1/2 OD	44
COATED COILS											
MALS-55A-P	550	4-1/2	10	14	125	5	.65	3/8 OD	1/2 OD	1/2 OD	9
MALS-105A-P	1050	4-1/2	16-1/2	14	125	5	.65	3/8 OD	1/2 OD	1/2 OD	12
MALS-135A-P	1350	4-1/2	20-1/2	14	225	(2)5	1.3	3/8 OD	1/2 OD	1/2 OD	16
MALS-190A-P	1700	4-1/2	24	14-1/2	225	(2)5	1.3	3/8 OD	1/2 OD	1/2 OD	21

LOW TEMPERATURE ELECTRIC DEFROST

PART#	BTU/HR 10° T.D.	DIMENSIONS			CFM	FAN DIA.	MTR AMPS	HEATERS AMPS	CONNECTIONS			APPROX. SHIP WT.
		H.	W.	D.					INLET	SUCTION	DRAIN	
MALS-50E1	500	4-1/2	10	14	125	5	.65	1.8	3/8 OD	1/2 OD	1/2 OD	10
MALS-95E1	950	4-1/2	16-1/2	14	125	5	.65	4.2	3/8 OD	1/2 OD	1/2 OD	13
MALS-125E1	1250	4-1/2	20-1/2	14	200	(2)5	1.3	4.31	3/8 OD	1/2 OD	1/2 OD	17
MALS-160E1	1600	4-1/2	24-1/2	15	225	(2)5	1.3	5.05	3/8 OD	1/2 OD	1/2 OD	19
MALS-210E1	2100	6-5/8	24	16-1/2	300	8	.73	7.52	1/2 OD	1/2 OD	1/2 OD	24
MALS-210E2	2100	6-5/8	24	16-1/2	300	8	.45	3.83	1/2 OD	1/2 OD	1/2 OD	24
MALS-280E1	2800	6-5/8	32	16-1/2	300	8	.73	11.7	1/2 OD	1/2 OD	3/4 OD	38
MALS-280E2	2800	6-5/8	32	16-1/2	300	8	.45	5.9	1/2 OD	1/2 OD	3/4 OD	38

*Textured aluminum cabinet * Compact unit for ceiling mount * Moisture proof wiring harness * Peerlite coating optional
* Front panel and drain are one piece for easy servicing * Easily adapted as a replacement unit or original equipment *
Thermally protected, permanently lubricated motors



MEDIUM TEMPERATURE – AIR DEFROST

PART#	BTU/HR 10° T.D.	DIMENSIONS			CFM	DIA.	AMPS	CONNECTIONS			APPROX. SHIP WT.
		H.	W.	D.				INLET	SUCTION	DRAIN	
MASF-105	1000	9	11-3/8	14	300	8	.73	3/8 OD	3/8 OD	1/2 OD	14
MASF-135	1300	9	14-3/8	14	300	8	.73	3/8 OD	3/8 OD	1/2 OD	16
MASF-175	1700	9	17-3/8	14	300	8	.73	3/8 OD	3/8 OD	1/2 OD	18
MASF-235	2300	9-7/8	20-3/8	15	300	8	.73	3/8 OD	1/2 OD	1/2 OD	22
MASF-305	3000	11	23-3/8	16	500	10	.75	1/2 OD	1/2 OD	1/2 OD	27
MASF-105-P	1000	9	11-3/8	14	300	8	.73	3/8 OD	3/8 OD	1/2 OD	14
MASF-135-P	1300	9	14-3/8	14	300	8	.73	3/8 OD	3/8 OD	1/2 OD	16
MASF-175-P	1700	9	17-3/8	14	300	8	.73	3/8 OD	3/8 OD	1/2 OD	18
MASF-235-P	2300	9-7/8	20-3/8	15	300	8	.73	3/8 OD	1/2 OD	1/2 OD	22
MASF-305-P	3000	11	23-3/8	16	500	10	.75	1/2 OD	1/2 OD	1/2 OD	27

*Textured aluminum cabinet * Compact unit for ceiling mount * Moisture proof wiring harness *
Peerlite coating optional * Front panel and drain are one piece for easy servicing * Easily adapted
as a replacement unit or original equipment * Thermally protected, permanently lubricated motors

MEDIUM TEMPERATURE UNIT COOLERS FOR REFRIGERATED CABINETS

AIR DEFROST

PART#	BTU/HR 10° T.D.	DIMENSIONS			CFM	FAN DIA.	115V MTR AMPS	INLET	CONNECTIONS			APPROX. SHIP WT.
		H.	W.	D.					SUCTION	DRAIN		
MAMJ-40	400	7	13-5/8	8	125	5	.65	3/8 OD	3/8 OD	1/2 OD	7	
MAMJ-70	700	7	13-5/8	8	125	5	.65	3/8 OD	3/8 OD	1/2 OD	9	
MAMJ-90	900	7	13-5/8	9	125	5	.65	3/8 OD	3/8 OD	1/2 OD	10	
MAMJ-120	1200	7	20-5/8	9	250 (2)	5	1.3	3/8 OD	3/8 OD	1/2 OD	15	
COATED COILS												
MAMJ-40-P	400	7	13-5/8	8	125	5	.65	3/8 OD	3/8 OD	1/2 OD	7	
MAMJ-70-P	700	7	13-5/8	8	125	5	.65	3/8 OD	3/8 OD	1/2 OD	9	
MAMJ-90-P	900	7	13-5/8	9	125	5	.65	3/8 OD	3/8 OD	1/2 OD	10	
MAMJ-120-P	1200	7	20-5/8	9	250 (2)	5	1.3	3/8 OD	3/8 OD	1/2 OD	15	



*Textured aluminum cabinet * Compact unit for ceiling or wall mount * Moisture proof wiring harness * Peerlite coating optional * Front panel and drain are one piece for easy servicing * Easily adapted as a replacement unit or original equipment *Thermally protected, permanently lubricated motors

MEDIUM TEMPERATURE – AIR DEFROST

PART#	BTU/HR 10° T.D.	DIMENSIONS			CFM	FAN DIA.	115V MTR AMPS	INLET	CONNECTIONS			APPROX. SHIP WT.
		H.	W.	D.					SUCTION	DRAIN		
MATM-100	1000	4-5/8	20-3/8	16	125	5	.65	3/8 OD	3/8 OD	1/2 OD	11	
MATM-135	1350	4-5/8	20-3/8	16	250 (2)	5	1.3	3/8 OD	3/8 OD	1/2 OD	15	
MATM-180	1800	4-5/8	20-3/8	16	250 (2)	5	1.3	3/8 OD	3/8 OD	1/2 OD	15	
MATM-250	2500	5-5/8	20-3/8	16	300	8	.73	3/8 OD	3/8 OD	1/2 OD	16	
COATED COILS												
MATM-100-P	1000	4-5/8	20-3/8	16	125	5	.65	3/8 OD	3/8 OD	1/2 OD	11	
MATM-135-P	1350	4-5/8	20-3/8	16	250 (2)	5	1.3	3/8 OD	3/8 OD	1/2 OD	15	
MATM-180-P	1800	4-5/8	20-3/8	16	250 (2)	5	1.3	3/8 OD	3/8 OD	1/2 OD	15	
MATM-250-P	2500	5-5/8	20-3/8	16	300	8	.73	3/8 OD	3/8 OD	1/2 OD	16	



*Textured aluminum cabinet * Compact unit for ceiling mount * Two way air discharge for uniform box temperature * Moisture proof wiring harness * Peerlite coating optional * Front panel and drain are one piece for easy servicing * Easily adapted as a replacement unit or original equipment * Thermally protected, permanently lubricated motors

UNIT COOLERS FOR REFRIGERATED ROOMS



MEDIUM TEMPERATURE

AIR DEFROST

PART#	BTU/HR 10° T.D.	DIMENSIONS			CFM	FAN DIA.	115V MTR AMPS	HEATERS AMPS	CONNECTIONS			MPT DRAIN	APPROX. SHIP WT.
		H.	W.	D.					INLET	SUCTION			
MAPLPH-410	4100	15-1/4	29-1/4	14-3/4	730	12	.06	3.9	1/2 OD	5/8 OD	3/4	37	
MAPLPH-530A	5300	15-1/4	29-1/4	14-3/4	700	12	.06	7.8	1/2 OD	5/8 OD	3/4	40	
MAPLPH-660A	6600	15-1/4	29-1/4	14-3/4	650	12	1.2	7.8	1/2 OD	7/8 OD	3/4	46	
MAPLPH-710A	7100	15-1/4	45-1/4	14-3/4	1460 (2)	12	1.2	7.8	1/2 OD	7/8 OD	3/4	54	
MAPLPH-1050A	10500	15-1/4	45-1/4	14-3/4	1400 (2)	10	1.2	11.7	1/2 OD	7/8 OD	3/4	58	
MAPLPH-2610A	26100	15-1/4	93-1/4	14-3/4	3500 (5)	10	3	15.7	1/2 OD	1-1/8 OD	3/4	112	
MAPLPH-3130A	31300	15-1/4	109-1/4	14-3/4	4200 (6)	10	3.6	23.5	1/2 OD	1-1/8 OD	3/4	133	

LOW TEMPERATURE

ELECTRIC DEFROST

PART#	BTU/HR 10° T.D.	DIMENSIONS			CFM	FAN DIA.	230V MTR AMPS	HEATERS AMPS	CONNECTIONS			MPT DRAIN	APPROX. SHIP WT.
		H.	W.	D.					INLET	SUCTION			
MAPLPH-360E	3600	15-1/4	29-1/4	14-3/4	700	12	.45	3.9	1/2 OD	5/8 OD	3/4	33	
MAPLPH-660E	6600	15-1/4	45-1/4	14-3/4	1400 (2)	12	.90	7.8	1/2 OD	5/8 OD	3/4	52	
MAPLPH-910E	9100	15-1/4	45-1/4	14-3/4	1300 (2)	12	.90	7.8	1/2 OD	7/8 OD	3/4	57	
MAPLPH-1210E	12100	15-1/4	61-1/4	14-3/4	2100 (3)	12	1.35	11.7	1/2 OD	7/8 OD	3/4	69	
MAPLPH-1810E	18100	15-1/4	77-1/4	14-3/4	2600 (4)	12	1.80	15.7	1/2 OD	1-1/8 OD	3/4	93	
MAPLPH-2010E	20100	15-1/4	93-1/4	14-3/4	3500 (5)	12	2.25	19.6	1/2 OD	1-1/8 OD	3/4	110	
MAPLPH-2410E	24100	15-1/4	109-1/4	14-3/4	4200 (6)	12	2.70	23.5	1/2 OD	1-1/8 OD	3/4	130	

*Standard with high efficiency EC motors * All motors are universal voltage 115-230V 50/60HZ with constant airflow * Internally enhanced tubing and fin design high efficiency * Textured aluminum cabinet * Compact unit for ceiling mount * Easy access front corner panels * Peerlite coil coating optional * Easily adapted as a replacement unit or original equipment * Motors Serviceable through fan guards * 12 inch fans for optimum air through

QUIET SWITCHES

Horsepower Rated
for Motor Loads
Rated - 15A
120V AC 1/2HP
Max. Amps - 12A
**UL APPROVED
ONLY**

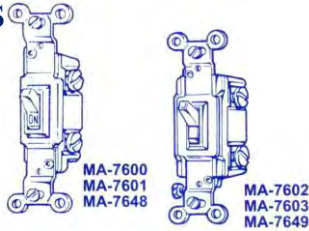

<u>SINGLE POLE, 15A, 115V</u>	<u>THREE WAY, 15A, 115V</u>
MA-7600 BROWN	MA-7602 BROWN
MA-7601 IVORY	MA-7603 IVORY
MA-7648 WHITE	MA-7649 WHITE

DUPLEX SWITCHES

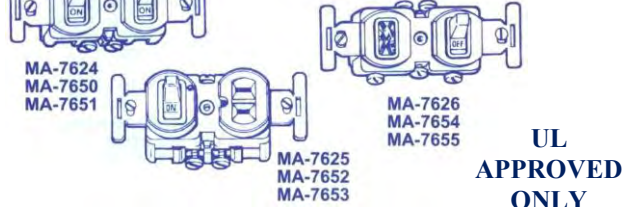

SINGLE POLE, 15A, 120-277V, AC SWITCH
MA-7624 IVORY **MA-7650** BROWN
MA-7651 WHITE

SINGLE POLE, 15A, 120-277V, AC SWITCH, 2P 3W
GROUNDING 15A, 125 RECEPTACLE
MA-7625 IVORY **MA-7652** BROWN
MA-7653TR WHITE

SINGLE POLE, 15A, 120-277V, AC SWITCH,
W/PILOT LIGHT 120V
MA-7626 IVORY **MA-7654** BROWN
MA-7655 WHITE

**UL
APPROVED
ONLY**

HEAVY DUTY QUIET SWITCHES

Horsepower Rated for
Motor Loads
Rated - 120V AC - 240V AC -
15A - 1/2HP - 1HP -
20A - 1HP - 2HP - 16A
UL APPROVED ONLY

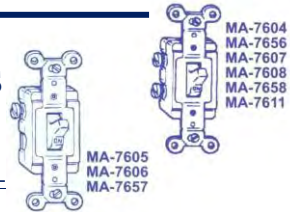

<u>DOUBLE POLE, 20A, 120-277V, AC SWITCH</u>	<u>THREE WAY, 20A, 120-277V, AC SWITCH</u>
MA-7604 BROWN	MA-7607 BROWN
MA-7656 WHITE	MA-7608 IVORY
MA-7611 IVORY	MA-7658 WHITE

SINGLE POLE, 20A, 120-277V, AC SWITCH
MA-7605 BROWN **MA-7606** IVORY
MA-7657 WHITE

DRYER AND RANGE RECEPTACLES



MA-7670 FLUSH MOUNT 30A, 125/250V
NEMA 10-30 DRYER RECEPTACLE, BROWN,
3 PRONG
UL APPROVED

MA-7671 SURFACE MOUNT 30A, 125/250V
NEMA 10-30 DRYER RECEPTACLE, BLACK,
3 PRONG
UL APPROVED

MA-7672 FLUSH MOUNT 50A, 125/250V
NEMA 10-50 RANGE RECEPTACLE, BLACK,
3 PRONG
UL & CSA APPROVED

MA-7673 SURFACE MOUNT 50A, 125/250V
NEMA 10-50 RANGE RECEPTACLE, BLACK,
3 PRONG
UL APPROVED

MA-1257 FLUSH MOUNT 30A, 125/250V
NEMA 14-30 RECEPTACLE, BLACK, 4 PRONG
UL & CSA APPROVED

MA-1225 SURFACE MOUNT 30A, 125/250V
NEMA 14-30 RECEPTACLE, BLACK, 4 PRONG
UL APPROVED

MA-1258 FLUSH MOUNT 50A, 125/250V
NEMA 14-50 RECEPTACLE, BLACK, 4 PRONG
UL & CSA APPROVED

MA-1212 SURFACE MOUNT 50A, 125/250V
NEMA 14-50 RECEPTACLE, BLACK, 4 PRONG
UL & CSA APPROVED

PROTECTIVE COVER UL & CSA APPROVED



MA-7621
PLASTIC SNAP COVER FOR DUPLEX RECEPTACLE
IN WET LOCATIONS

GFI DUPLEX RECEPTACLE



UL APPROVED ONLY

MA-7518
DUPLEX RECEPTACLE, GROUND FAULT CIRCUIT
INTERRUPTERS 15A, 125V, NEMA 5-15, WHITE

SINGLE POLE RATED:
15A AT 125VAC - 10A AT 250VAC - 3/4HP AT 125/250VAC

DOUBLE POLE RATED:
15A AT 125VAC - 10A AT 250VAC - 1.5HP AT 125/250VAC

SINGLE POLE
MA04501-2 SP-ST
MA04502-2 SP-DT
MA04503-2
SP-DT CENTER-OFF

**TOGGLE
SWITCHES**
ALL TOGGLE
SWITCHES
FURNISHED WITH
SCREW TERMINALS



DOUBLE POLE
MA04504-2 DP-ST
MA04505-2 DP-DT
MA04506-2
DP-DT CENTER OFF

STRAIGHT BLADE RECEPTACLES

E-Z ground strap w/grounding terminal screw.
 Suitable for grounded metallic or non-metallic systems.
 Compact design provides more wiring space in outlet box.
 UL File E15058RTRT

- MA-7612** SIDE WIRE, 2P, 3W GROUNDING 15A, 125V, NEMA 5-15R, DUPLEX RECEPTACLE, BROWN **UL & CSA APPROVED**
- MA-7613** SIDE WIRE, 2P, 3W GROUNDING 15A, 125V, NEMA 5-15R, DUPLEX RECEPTACLE, IVORY **UL & CSA APPROVED**
- MA-7659** SIDE WIRE, 2P, 3W GROUNDING 15A, 125V, NEMA 5-15R, DUPLEX RECEPTACLE, WHITE **UL & CSA APPROVED**
- MA-7614** SINGLE, 15A, 125V, NEMA 5-15R, BROWN **UL APPROVED**
- MA-7615** SINGLE, 15A, 125V, NEMA 5-15R, IVORY **UL APPROVED**
- MA-7662** SINGLE, 15A, 125V, NEMA 5-15R, WHITE **UL APPROVED**
- MA-7617** SIDE WIRE, 2P, 3W GROUNDING 20A, 125V, NEMA 5-10R, DUPLEX RECEPTACLE, BROWN **UL APPROVED**
- MA-7618** SIDE WIRE, 2P, 3W GROUNDING 20A, 125V, NEMA 5-10R, DUPLEX RECEPTACLE, IVORY **UL APPROVED**
- MA-7660** SIDE WIRE, 2P, 3W GROUNDING 20A, 125V, NEMA 5-10R, DUPLEX RECEPTACLE, WHITE **UL & CSA APPROVED**
- MA-7514** E-Z WIRE & SCREW, 15A, 125V NEMA 5-15R, DUPLEX RECEPTACLE, BROWN **UL APPROVED**
- MA-7515** E-Z WIRE & SCREW, 15A, 125V NEMA 5-15R, DUPLEX RECEPTACLE, IVORY **UL APPROVED**
- MA-7661** E-Z WIRE & SCREW, 15A, 125V NEMA 5-15R, DUPLEX RECEPTACLE, WHITE **UL APPROVED**

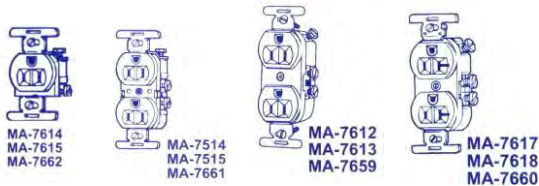

STRAIGHT BLADE PLUGS, CONNECTORS, & ADAPTORS



- MA-179ED** PLASTIC HANDLE PLUG 15A, 125V, 2 POLE, 2-WIRE 13/32" CORD HOLE (2/BAG) **UL & CSA APPROVED**
- MA-7525** 3 WIRE RECEPTACLE TO 3 WIRE GROUNDING OUTLET VINYL, 15A, 125V, GRAY **UL APPROVED**
- MA-7599** TRI-TAP, 15A, 125V, NEMA 1-15
- MA-7638** VINYL PLUG 20A, 125V NEMA 5-20, YELLOW **UL & CSA APPROVED**
- MA-7639** VINYL PLUG CONNECTOR 20A, 125V, NEMA 5-20, YELLOW **UL APPROVED**



- MA-7640** VINYL ARMORED CONNECTOR 15A, 125V, NEMA 5-15, YELLOW **UL & CSA APPROVED**
- MA-7641** VINYL ARMORED PLUG 15A, 125V, NEMA 5-15, YELLOW **UL & CSA APPROVED**
- MA-7642** VINYL ARMORED CONNECTOR 15A, 250V, NEMA 6-15, YELLOW **UL & CSA APPROVED**
- MA-7643** VINYL ARMORED PLUG 15A, 250V, NEMA 6-15, YELLOW **UL & CSA APPROVED**
- MA-7644** VINYL ARMORED PLUG 20A, 250V, NEMA 6-20, YELLOW **UL & CSA APPROVED**



- MA-7645** VINYL ARMORED CONNECTOR 20A, 250V, NEMA 6-20, YELLOW
- MA-7646** RUBBER CONNECTOR, ROUND HANDLE CONNECTOR, 15A, 250V NEMA 5-15, BLACK **UL APPROVED**
- MA-7647** RUBBER PLUG, ROUND HANDLE CONNECTOR, 15A, 250V NEMA 5-15, BLACK **UL & CSA APPROVED**

WALL PLATES

- MA-7630** ONE GANG TOGGLE, SMOOTH LINE, BROWN
- MA-7631** ONE GANG TOGGLE, SMOOTH LINE, IVORY
- MA-7663** ONE GANG TOGGLE, SMOOTH LINE, WHITE
- MA-7632** DUPLEX, SMOOTH LINE, BROWN
- MA-7633** DUPLEX, SMOOTH LINE, IVORY
- MA-7664** DUPLEX, SMOOTH LINE, WHITE
- MA-7634** TWO GANG TOGGLE, SMOOTH LINE, BROWN
- MA-7635** TWO GANG TOGGLE, SMOOTH LINE, IVORY
- MA-7665** TWO GANG TOGGLE, SMOOTH LINE, WHITE
- MA-7636** TOGGLE AND DUPLEX, SMOOTH LINE, BROWN
- MA-7637** TOGGLE AND DUPLEX, SMOOTH LINE, IVORY
- MA-7667** TOGGLE AND DUPLEX, SMOOTH LINE, WHITE
- MA-7668** BLANK, PLASTIC, BROWN
- MA-7669** BLANK, PLASTIC, IVORY
- MA-7674** BLANK, PLASTIC, WHITE

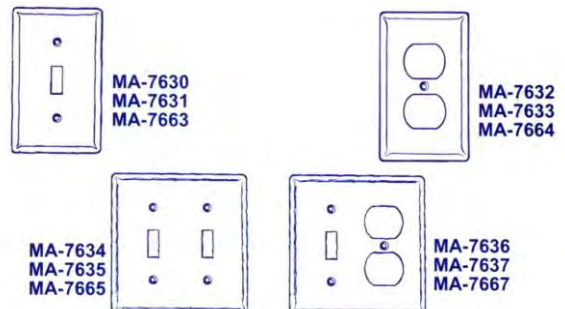



SQUARE D DEFINITE PURPOSE CONTACTORS

2-POLE-SMALL FRAME 3-POLE-LARGE FRAME

	FULL LOAD AMPERES	COIL VAC		FULL LOAD AMPERES	COIL VAC
8910DP22V14	25	24	8910DPA23V14	25	24
8910DP22V02	25	120	8910DPA23V02	25	120
8910DP22V09	25	240	8910DPA23V09	25	240
8910DP32V14	30	24	8910DPA33V14	30	24
8910DP32V02	30	120	8910DPA33V02	30	120
8910DP32V09	30	240	8910DPA33V09	30	240
8910DP42V14	40	24	8910DPA43V14	40	24
8910DP42V02	40	120	8910DPA43V02	40	120
8910DP42V09	40	240	8910DPA43V09	40	240
			8910DPA53V14	50	24
			8910DPA53V02	50	120
			8910DPA53V09	50	240
			8910DPA63V14	60	24
			8910DPA63V02	60	120
			8910DPA63V09	60	240
			8910DPA73V14	75	24
			8910DPA73V02	75	120
			8910DPA73V09	75	240
			8910DPA93V14	90	24
			8910DPA93V02	90	120
			8910DPA93V09	90	240

Ideal for Heating, A/C, Refrigeration, Data Processing, and Food Service Equipment.

Features: UL Component Recognized, UL Listed, CSA Certified, and DPA series is CE marked.

Specifications: Up to 30 Ampere; Quick Connect Terminals and binder head screws for easy wiring. 40 Ampere and Larger; box lugs are standard



WORLD SOURCE DEFINITE PURPOSE CONTACTORS

1-POLE

	FULL LOAD AMPERES	COIL VAC
1P30A24V	30	24
1P40A24V	40	24

1.5 POLE

	FULL LOAD AMPERES	COIL VAC
112P30A24V	30	24
112P30A120V	30	120
112P30A240V	30	240

2-POLE

	FULL LOAD AMPERES	COIL VAC
2P20A24V	20	24
2P30A24V	30	24
2P30A120V	30	120
2P30A240V	30	240
2P40A24V	40	24
2P40A120V	40	120
2P40A240V	40	240

UNIVERSAL MOUNT
LUG TERMINAL
WITH QUICK CONNECT

3-POLE

	FULL LOAD AMPERES	COIL VAC
3P30A24V	30	24
3P30A120V	30	120
3P30A240V	30	240
3P40A24V	40	24
3P40A120V	40	120
3P40A240V	40	240
3P50A24V	50	24
3P50A120V	50	120
3P50A240V	50	240
3P60A24V	60	24
3P60A120V	60	120
3P60A240V	60	240

Compatible with American Switch, Westinghouse (Bryant), Challenger (Sylvania), Crouse-Hinds (Murray), Frank Adams, General Electric (full size only), General Switch, I-T-E Gould, Montgomery Wards and Sears.

SINGLE POLE, 120/240VAC COMMON TRIP

MA-Q115	15AMP
MA-Q120	20AMP
MA-Q125	25AMP
MA-Q130	30AMP
MA-Q140	40AMP
MA-Q150	50AMP
MA-Q160	60AMP



UL & CSA
APPROVED

DUAL SINGLE POLE, 120/240VAC

MA-QT1515	15-15AMP
MA-QT1520	15-20AMP
MA-QT2020	20-20AMP



DUAL
SINGLE POLE, 120/240VAC
MA-QT2030 20-30AMP
MA-QT3030 30-30AMP

REPLACEMENTS FOR SQUARE D

SINGLE POLE, 120/240VAC	
MA-D115	15AMP
MA-D120	20AMP
MA-D130	30AMP
MA-D140	40AMP
MA-D150	50AMP
MA-D160	60AMP



UL & CSA
APPROVED

REPLACEMENTS FOR SQUARE D

DOUBLE POLE, 120/240VAC	
MA-D215	15AMP
MA-D220	20AMP
MA-D230	30AMP
MA-D240	40AMP
MA-D250	50AMP
MA-D260	60AMP

SQUARE D CIRCUIT BREAKERS UL & CSA LISTED

HOMELINE®

SINGLE POLE,
120/240VAC

HOM115	15AMP
HOM120	20AMP
HOM130	30AMP
HOM140	40AMP
HOM150	50AMP



HOMELINE®

DOUBLE POLE,
120/240VAC

HOM215	15AMP
HOM220	20AMP
HOM230	30AMP
HOM240	40AMP
HOM250	50AMP
HOM260	60AMP

QO STYLE

WITH VISI-TRIP®

SINGLE POLE,
120/240VAC

QO115	15AMP
QO120	20AMP
QO130	30AMP
QO140	40AMP
QO150	50AMP
QO160	60AMP



QO STYLE

WITH VISI-TRIP®

DOUBLE POLE,
120/240VAC

QO215	15AMP
QO220	20AMP
QO230	30AMP
QO240	40AMP
QO250	50AMP
QO260	60AMP

VISI-TRIP® =
VISUAL RED INDICATOR
IN WINDOW

VISI-TRIP® =
VISUAL RED INDICATOR
IN WINDOW

**4" SQUARE TWO DEVICE
OUTLET BOXES**

MA-E374 (50/PKG)

4"SQ x 1-1/2"
WITH 1/2" KNOCKOUTS

MA-E374D (25/PKG)

4"SQ x 2-1/8"



**4" COVERS FOR TWO
DEVICE OUTLET BOXES**

MA-E272 2-TOGGLE SWITCHES
(50/PKG) FIG. A

MA-E273 1 TOGGLE SWITCH & 1
DUPLEX RECEPTACLE (50/PKG)
FIG. B

MA-E274 2 DUPLEX RECEPTACLE
(25/PKG) FIG. C

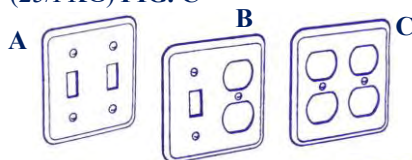

**4-11/16" COVERS
FOR SQUARE
OUTLET BOXES**

MA-E584 4-11/16" FLATSQUARE
BLANK COVER (25/PKG) FIG. A

MA-E590 4-11/16" RAISED SQUARE
SINGLE DEVICE (25/PKG) FIG. C

MA-E594 4-11/16" FLAT SQUARE
KNOCKOUT IN CENTER (25/PKG) FIG. B

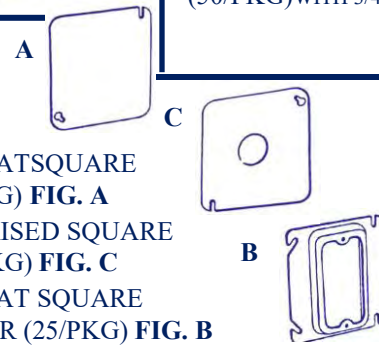

4" SQUARE OUTLET

MA-E554 4" FLAT SQUARE
BLANK COVER (50/PKG) FIG. A

MA-E560 4" SQUARE 1/2" RAISED
SINGLE FLUSH (50/PKG) FIG. B

MA-E564 4" FLAT SQUARE WITH
1/2" KNOCKOUT IN CENTER (50/PKG) FIG. C

MA-E570 4" SQUARE 1/2" RAISED
1 TOGGLE SWITCH (50/PKG) FIG. D

MA-E571 4" SQUARE 1/2" RAISED
1 DUPLEX RECEPTACLE (50/PKG) FIG. E

MA-E572 4" SQUARE 1/2" RAISED
2 TOGGLE SWITCHES (50/PKG) FIG. F

MA-E573 4" SQUARE 1/2" RAISED
1 SWITCH & DUPLEX RECPT(50/PKG) FIG. G

MA-E574 4" SQUARE 1/2" RAISED
TWO DUPLEX RECEPTACLES (50/PKG) FIG. H

MA-E575 4" SQUARE 1/2" RAISED
SINGLE RECEPTACLE 1-13/32" (50/PKG) FIG. I

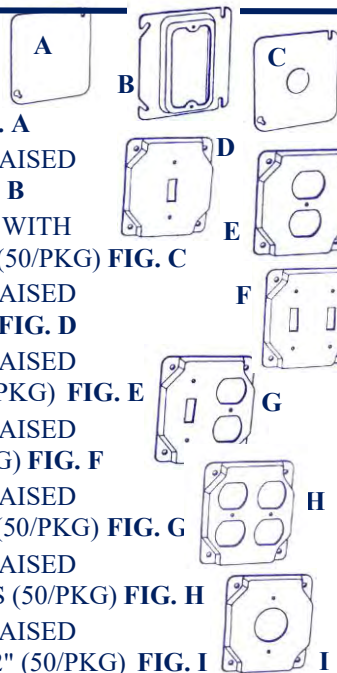

**4" SQUARE
OUTLET BOXES**

MA-E352 4"SQ x 1-1/4"
(50/PKG) WITH 1/2" KNOCKOUTS

MA-E353 4"SQ x 1-1/2"
(50/PKG) WITH 1/2" & 3/4" KNOCKOUTS

MA-E353D 4"SQ x 2-1/8"
(50/PKG) WITH 1/2" & 3/4" KNOCKOUTS

MA-E363D 4-11/16"SQ x 2-1/8"
(25/PKG) WITH 1/2" & 3/4" KNOCKOUTS



STANDARD UTILITY BOXES

MA-E200 4"L x 2-1/8"W X 1-1/2"D
(50/PKG) WITH 1/2" KNOCKOUTS

MA-E201 4"L x 2-1/8"W X 1-7/8"D
(50/PKG) WITH 1/2" KNOCKOUTS

MA-E202 4"L x 2-1/8"W X 2-1/8"D
(50/PKG) WITH 1/2" KNOCKOUTS

MA-E201-3/4 4"L x 2-1/8"W X 1-7/8"D
(50/PKG) WITH 3/4" KNOCKOUTS



**4" OCTAGON
OUTLET BOXES**

MA-E303 4" x 1-1/2"
WITH 1/2" & 3/4" KNOCKOUTS
(50/PKG)

MA-E303D 4" x 2-1/8"
WITH 1/2" & 3/4" KNOCKOUTS
(25/PKG)



EXTENSION RINGS

MA-E304EXT 4" x 1-1/2"
OCTAGON WITH 1/2"
KNOCKOUTS
(50/PKG) FIG. A

MA-E350EXT 4" x 1-1/2"
SQUARE WITH 1/2" & 3/4"
KNOCKOUTS
(50/PKG) FIG. B

MA-E200EXT 4" x 2-1/8"
RECTANGLE
(50/PKG) FIG. C

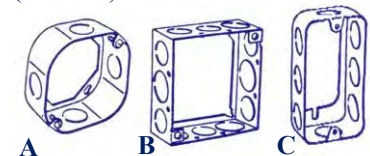

**4" OCTAGON
OUTLET BOX COVERS**

MA-E504 4" FLAT OCTAGON
BLANK COVER (50/PKG)

MA-E508D 4" OCTAGON
DUPLEX RECEPTACLE (50/PKG)

MA-E508T 4" FLAT OCTAGON
TOGGLE SWITCH (50/PKG)

MA-E509 4" FLAT OCTAGON
KNOCKOUT IN CENTER (50/PKG)

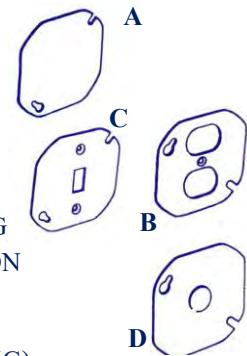

**STANDARD HANDY
BOX COVERS**

MA-E251 4" X 2-1/8"
SINGLE RECEPTACLE FIG. A

MA-E252 4" X 2-1/8"
DUPLEX RECEPTACLE FIG. B

MA-E253 4" X 2-1/8"
TOGGLE SWITCH FIG. C

MA-E254 4" X 2-1/8"
BLANK FIG. D

MA-E255 4" X 2-1/8"
1-1/2" KNOCKOUT FIG. E

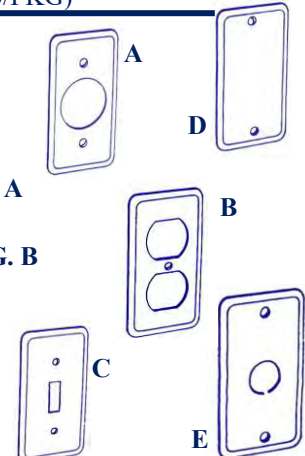

CONDENSER & HEAT EXCHANGER BRUSHES



PART#		FEMALE THREADS	BRUSH LENGTH
STAINLESS STEEL SINGLE SPIRAL			
AMA-502	1/4" DIA.	8-32	3"
AMA-504	3/8" DIA.	12-24	4"
AMA-507	7/16" DIA.	12-24	4"
AMA-510	1/2" DIA.	12-24	4"
AMA-513	9/16" DIA.	12-24	4"
AMA-516	5/8" DIA.	12-24	4"
AMA-519	11/16" DIA.	12-24	4"
AMA-522	3/4" DIA.	12-24	4"
AMA-525	13/16" DIA.	12-24	4"
AMA-528	7/8" DIA.	12-24	4"
AMA-531	15/16" DIA.	12-24	4"
AMA-533	1" DIA.	12-24	4"
BRASS WIRE SINGLE SPIRAL			
AMA-602	1/4" DIA.	8-32	3"
AMA-604	3/8" DIA.	12-24	4"
AMA-607	7/16" DIA.	12-24	4"
AMA-610	1/2" DIA.	12-24	4"
AMA-613	9/16" DIA.	12-24	4"
AMA-616	5/8" DIA.	12-24	4"
AMA-619	11/16" DIA.	12-24	4"
AMA-622	3/4" DIA.	12-24	4"
AMA-625	13/16" DIA.	12-24	4"
AMA-628	7/8" DIA.	12-24	4"
AMA-631	15/16" DIA.	12-24	4"
AMA-633	1" DIA.	12-24	4"
BLACK NYLON WIRE SINGLE SPIRAL			
AMA-702	1/4" DIA.	8-32	3"
AMA-704	3/8" DIA.	12-24	4"
AMA-707	7/16" DIA.	12-24	4"
AMA-710	1/2" DIA.	12-24	4"
AMA-713	9/16" DIA.	12-24	4"
AMA-716	5/8" DIA.	12-24	4"
AMA-719	11/16" DIA.	12-24	4"
AMA-722	3/4" DIA.	12-24	4"
AMA-725	13/16" DIA.	12-24	4"
AMA-728	7/8" DIA.	12-24	4"
AMA-731	15/16" DIA.	12-24	4"
AMA-733	1" DIA.	12-24	4"

AMA-044 4' EXTENSION X .162"DIA. 8-32 MALE
THREAD FOR USE WITH 1/4" AND 5/16"DIA.

THE ITEM BELOW IS FOR CONDENSER BRUSHES



COPPER TUBE FITTING BRUSHES

SINGLE SPIRAL – 2 PLY WIRE CONSTRUCTION
STAINLESS STEEL WIRE
SOLID PLASTIC HAND-FITTING HANDLE



AMA-824	1/4"OD – 1/8"ID	AMA-831	1-1/8"OD – 1"ID
AMA-825	3/8"OD – 1/4"ID	AMA-832	1-3/8"OD – 1-1/8"ID
AMA-826	1/2"OD – 3/8"ID	AMA-833	1-1/2"OD – 1-3/8"ID
AMA-827	5/8"OD – 1/2"ID	AMA-834	1-5/8"OD – 1-1/2"ID
AMA-828	3/4"OD – 5/8"ID	AMA-835	2-1/8"OD – 2"ID
AMA-829	7/8"OD – 3/4"ID	AMA-836	2-1/2"OD – 2-1/8"ID
AMA-830	1"OD – 7/8"ID		
DOUBLE SPIRAL – 4 PLY WIRE CONSTRUCTION STAINLESS STEEL WIRE – SOLID PLASTIC HAND-FITTING HANDLE			
AMA-924	1/4"OD – 1/8"ID	AMA-931	1-1/8"OD – 1"ID
AMA-925	3/8"OD – 1/4"ID	AMA-932	1-3/8"OD – 1-1/8"ID
AMA-926	1/2"OD – 3/8"ID	AMA-933	1-1/2"OD – 1-3/8"ID
AMA-927	5/8"OD – 1/2"ID	AMA-934	1-5/8"OD – 1-1/2"ID
AMA-928	3/4"OD – 5/8"ID	AMA-935	2-1/8"OD – 2"ID
AMA-929	7/8"OD – 3/4"ID	AMA-936	2-1/2"OD – 2-1/8"ID
AMA-930	1"OD – 7/8"ID		

OUTSIDE TUBE CLEANING BRUSHES

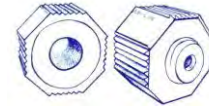

AMA-960	1/4", 3/8", 1/2", 5/8" 3/4" and 7/8"OD – SET OF 6	AMA-966	5/8"OD – 1/2"ID
AMA-963	1/4"OD – 1/8"ID	AMA-967	3/4"OD – 5/8"ID
AMA-964	3/8"OD – 1/4"ID	AMA-968	7/8"OD – 3/4"ID
AMA-965	1/2"OD – 3/8"ID	AMA-969	1"OD – 7/8"ID
		AMA-970	1-1/8"OD – 1"ID

FLUX/ACID BRUSHES



FOR
BRAZING
AND
SOLDERING

SOLD BY THE GROSS	PREPACKAGED
AMA-001 3/8" TIN HANDLE	AMA-001-10 (10/PKG) 3/8" TIN HANDLE
AMA-002 1/2" TIN HANDLE	AMA-002-10 (10/PKG) 1/2" TIN HANDLE
AMA-003 5/8" TIN HANDLE	AMA-003-5 (5/PKG) 5/8" TIN HANDLE
SOLD INDIVIDUALLY AMA-007 3/4" WOODEN HANDLE	AMA-007-2 (2/PKG) 3/4" WOODEN HANDLE



AMA-130	4" X 1/2"DIA. HANDGRIP (ONLY)12-24 SCREW
AMA-132	2' EXTENSION X 5/16"DIA. 12-24 THREADS ON ONE END AND FEMALE THREAD ON THE OTHER END
AMA-133	3' EXTENSION FOR USE WITH 3/8" THRU 1"DIA.

THE ABOVE ITEMS ARE FOR CONDENSER BRUSHES

CONDENSER TUBE BRUSH-SPIN-GRIT™



PART#		THREADS
MA-43482	1/2" DIA.	8-32F
MA-43484	3/4" DIA.	12-24F
MA-43486	1" DIA.	12-24F
MA-43488	1-1/4" DIA.	12-24F
MA-93482	1/2" DIA.	8-32M
MA-93484	3/4" DIA.	1/4-28M
MA-93486	1" DIA.	1/4-28M
MA-93488	1-1/4" DIA.	1/4-28M

BRUSH DIA.	TUBE SIZE
1/2"	1/4" - 5/16"
3/4"	3/8" - 9/16"
1"	5/8" - 11/16"

Spin Grit™ utilizes the sides of its impregnated nylon filaments to increase the brush's effectiveness!

* Polish tube interiors without scratching * Fits all commercial tube cleaners and rods * Moves through tube with less effort * Lasts up to 3 times longer than conventional brushes

The MA-43482 and MA-93482 use the AMA-044 Extension Rod.
The MA-43484, MA-43486, MA-43488, MA-93484, MA-93486 and MA-93488 use the AMA-132 or the AMA-133 Extension Rod.



NYLON TUBE BRUSHES

15" OVERALL LENGTH

AMA-530 3/4" X 3"
AMA-539 1" X 4"

15" OVERALL LENGTH

AMA-565 1-1/2" X 4"
AMA-582 2" X 4"



COLUMBIA BOILER BRUSH

AMA-348 1-1/2" X 1" X 4"

The bristles stick out in all directions and are rough cut to a rectangular shape. It is a much lighter fill than the flat style.



CLEANING BRUSHES

CLEANING BRUSH 24" OVERALL LENGTH – BRUSH LENGTH 7"

AMA-762 2" DIA. BLACK BRISTLE
AMA-763 2-1/2" DIA. SYNTHETIC BLACK HORSEHAIR
AMA-765 2-1/2" DIA. BLACK HORSEHAIR – POLY MIX

DUCT/VENT 48" OVERALL LENGTH – BRUSH LENGTH 7"

AMA-200 2-1/8" DIA. BRASS BRISTLE
AMA-210 2-1/8" DIA. STAINLESS STEEL
AMA-220 2-1/8" DIA. BLACK FIBER

CLOTHES DRYER VENT BRUSH

WITH 10' FLEXIBLE HANDLE

AMA-410

FEATURES:

REDUCES DRYING TIME
CONSERVES ENERGY
LOWERS UTILITY BILLS
PREVENTS VENT FIRES
EXTENDS DRYER LIFE



FLUE AND FURNACE BRUSHES

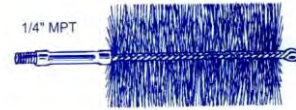

Brush Dimensions
4-1/2" Long

PART#	FLUE SIZE	BRUSH DIA.	PART#	FLUE SIZE	BRUSH DIA.
SINGLE SPIRAL THREADED NIPPLES			DOUBLE SPIRAL THREADED NIPPLES		
AMA-206	1"	3/4"	AMA-306	1"	3/4"
AMA-208	1-1/4"	1"	AMA-308	1-1/4"	1"
AMA-212	1-1/2"	1-1/4"	AMA-312	1-1/2"	1-1/4"
AMA-214	1-3/4"	1-1/2"	AMA-314	1-3/4"	1-1/2"
AMA-216	2"	1-3/4"	AMA-316	2"	1-3/4"
AMA-218	2-1/4"	2"	AMA-318	2-1/4"	2"
AMA-222	2-1/2"	2-1/4"	AMA-322	2-1/2"	2-1/4"
AMA-224	2-3/4"	2-1/2"	AMA-324	2-3/4"	2-1/2"
AMA-226	3"	2-3/4"	AMA-326	3"	2-3/4"
AMA-228	3-1/4"	3"	AMA-328	3-1/4"	3"
AMA-232	3-1/2"	3-1/4"	AMA-332	3-1/2"	3-1/4"
AMA-234	3-1/4"	3-1/2"	AMA-334	3-1/4"	3-1/2"
AMA-236	4"	3-3/4"	AMA-336	4"	3-3/4"

FLUE AND FURNACE BRUSH HANDLES & EXTENSIONS



AMA-438 & AMA-548



AMA-1438 & AMA-1448

AMA-438 4' HANDLE 1/4" FPT
AMA-548 5' HANDLE 1/4" FPT
AMA-1438 4' EXTENSION 1/4" MPT AT ONE END AND 1/4" FPT AT THE OTHER END
AMA-1448 5' EXTENSION 1/4" MPT AT ONE END AND 1/4" FPT AT THE OTHER END



BOILER BRUSH

AMA-406 EXTRA LONG HANDLE – STIFF WIRE BOILER BRUSH - BRUSH DIA. 3/4" X 4" – OVERALL LENGTH 42"

WIRE BRUSHES



AMA-010 TEMPERED CARBON STEEL BRISTLES 14" HARDWOOD CURVED HANDLE

AMA-018 STAINLESS STEEL BRISTLES 14" HARDWOOD CURVED HANDLE



AMA-017 TEMPERED CARBON STEEL BRISTLES 10" HARDWOOD SHOE HANDLE



GRILL CLEANING BRUSH WITH SCRAPER

MA-46810
STAINLESS STEEL BRISTLES WITH RUBBER GRIP

OIL OR CHIP BRUSH



AMA-481

REFRIGERATOR COIL CLEANING BRUSH



AMA-405

BRUSH LENGTH 15"
WOOD HANDLE 12"
OVERALL LENGTH 27"

NEW PARTS CLEANING BRUSH



AMA-015
POLY BRUSH MATERIAL
OVERALL LENGTH 10-3/4"

WELDERS "TOOTHBRUSH"



MA-20534 STAINLESS STEEL BRUSH 8" OVERALL WITH WOODEN HANDLE

AMA-254 BRASS BRUSH 7" OVERALL WITH WOODEN HANDLE

STAINLESS WIRE BRUSH

AMA-816



VARNISH BRUSH



AMA-503 2" POLYESTER BRISTLES

AMA-505 3" POLYESTER BRISTLES

CONDENSER FIN WHISK BRUSH

AMA-026

PLASTIC HANDLE WHISK FOR CLEANING CONDENSER FINS AND EVAPORATORS



RADIATOR CLEANING BRUSH



AMA-020
BLACK HORSEHAIR
OVERALL LENGTH 24"
BRUSH LENGTH 9"

A

ACCESS FITTING 25
ADAPTOR KIT, QUICK CHANGE 37
AIR FLOW METER, DIGITAL 8
AIR PRESSURE SWITCH TUBING 17
AIR TUBING 17
ALLIGATOR CLIPS, LOW VOLTAGE 56
ALUMINUM FOIL TAPE 64
ALUMINUM TUBING 17
ANCHOR KITS 54
ANTI-SHORT BUSHINGS 22

B

BAND HEATER, REFRIGERANT CYLINDER .. 33
BATTERIES 59
BOILER GAUGES 48
BOOKS
 MODERN REFRIGERATION & AC 60
BORESCOPE 7
BOX COVER UNITS, BUSSMAN 20
BRASS INSERTS 62
BREAKAWAY BRASS FITTINGS 17
BRUSHES
 BOILER 76
 CLEANING 75
 CONDENSER AND HEAT EXCHANGER 75
 CONDENSER FIN WHISK 77
 CONDENSER TUBE 76
 COPPER TUBE FITTING 75
 EXTENSIONS 76
 FLUE AND FURNACE 76
 FLUX AND ACID 75
 GRILL CLEANING 77
 NEW PARTS CLEANING 77
 NYLON TUBE 76
 OIL OR CHIP 77
 RADIATOR CLEANING 77
 REFRIGERATOR COIL CLEANING 75
 VARNISH 77
 VENT AND CLOTHES DRYER 76
 WELDERS TOOTHBRUSH 77
 WIRE 77

C

CABLE CLAMPS NYLON 49
CABLE METAL CLAD 22
CALIPERS DIAL, DIGITAL, STEEL 41
CAPACITOR TESTER 9
CAPILLARY TUBE CUTTER 35
CARBON MONOXIDE DETECTOR 9
CAULK 63
CAULKING GUNS 63
CEMENT
 BLACK FLASHING 63
 FURNACE CEMENT 63
CHISEL SCRAPER 39
CIRCUIT BREAKERS
 REPLACEMENT FOR SQUARE D-STYLE 73
 SIEMENS 73
 SIEMENS DUAL 73
 SQUARE D 73
CIRCUIT TESTERS 56
CLAMPS
 PIPE CLAMPS 18
CLAMP ON ADAPTOR 6
COMPRESSOR
 LEADS 56
CONDENSER FAN RAIN SHIELD 65
CONDENSATE PANS 61
CONDENSATE TRAPS 64
CONDENSER CLEANING TOOL 68
CONDUIT
 ALUMINUM 22
 FLEXIBLE 22
 LIQUID TIGHT 22

C (CONTINUED)

CONNECTORS
 BUTT SPLICE 50
 CLOSED END 50
CONTACTORS 73
COPPER SPUN DRIERS 24
COPPER STRAPS 18
CORK & RUBBER PADS 42
CORK TAPE 64
CRANKCASE HEATERS 61

D

DATA LOGGERS 7
DE-BURRING TOOL 35
DEFROST THERMOSTATS 45
DELTRON SLEEVE 62
DISCONNECT BOXES, AIR CONDITIONING
 METAL 21
 THREE PHASE 21
DRAIN HEATER, UNIVERSAL 61
DRAIN TUBING 17
DRAIN LINE ELBOWS 17
DRIERS
 COPPER SPUN DRIERS 24
 LIQUID LINE FILTER DRIERS 24
DRILL SETS 36
DRYER & RANGE RECEPTACLES 71
DUCT TAPE 64
DUCT TIES 48
DUST MASKS 44

E

ELECTRICAL TAPE 64
ENVIRONMENTAL KIT 8
EVACUATION QUICK PIERCE TOOL 39
EXTENSION CORDS 34
EXTENSION RINGS 74

F

FAN BLADES 66
FAN BLADE PITCH GAUGE 66
FIN COMBS 35
FIRST AID KIT 44
FITTINGS
 BLACK IRON PIPE 27
 BX-FLEXIBLE METAL CONDUIT 22
 FERNCO COUPLINGS 31
 LIQUID TIGHT – METAL 21
 LIQUID TIGHT – NON METALLIC 21
 NYLON 29
 PVC 28
 RIDGID CONDUIT 23
 THINWALL CONDUIT (EMT) 23
FLAME SHEILDS 62
FLARE NUT WRENCH SET 37
FLASHING CEMENT 63
FLASHLIGHTS 32
FLOOD ALERT 16
FOAM SEALANT 63
FOAM TAPE 64
FREEZE ALERT 16
FURNACE BLOCK 21
FURNACE CEMENT 63
FURNACE LIGHTER – TELESCOPIC 37
FUSE ADAPTOR - TYPE S 19
FUSE HOLDER – IN-LINE 20
FUSE PULLERS 20
FUSE REDUCER 20
FUSES 19

G

GARDEN HOSE 68
GARDEN HOSE NOZZLE 68
GAS BALL VALVES 59

G (CONTINUED)

GAS CONNECTORS – FLEXIBLE 59
GASKET MATERIAL 67
GASKET SCRAPER 39
GAUGE BOOTS – PROTECTIVE 59
GAUGES – BOILER GAUGES 59
GAS PRESSURE TEST GAUGE 59
GLYCOL REFRACTOMETER 61
GREASE 44
GREASE GUNS 44
GROMMET KIT – RUBBER 65
GROMMETS 49

H

HACKSAWS & BLADES 41
HANGER STRAP – PLASTIC 18
HANGING WIRE 18
HARD START KITS – EXTRA BOOST 21
HEAT GUNS 62
HEAT PUMP STANDS 21
HEX KEY ADAPTOR 37
HEX KEY SETS 35
HOLESAW KITS 35
HOSE CLAMPS 18
HOSE CUTTER 35
HUB PULLER 35
HUMIDIFIER HOOK UP KIT 62
HUMIDITY/TEMPERATURE TESTER 7

I

ICE MAKER & HUMIDIFIER
 HOOK UP KITS 62
INFRARED THERMOMETER 12
IN-LINE SPLICE 50
INSPECTION MIRRORS 11

J

J-HOOKS 18

K

KNIVES 40
KNEE PADS 44

L

LABELS – REFRIGERANT 60
LASER TAPE MEASURE 10
LED FLASHLIGHTS 32
LEVELS 41
LINE VOLTAGE CORD ADAPTORS 56
LIQUID LEVEL SWITCHES FOR
 RECOVERY CYLINDERS 60
LIQUID LINE FILTER DRIER 25
LOCKING PINCH-OFF TOOL 39
LUG MOUNTING BRACKET 65

M

MAGNA-LITE 33
MAGNETIC ASSORTED BITS 42
MAGNETIC PARTS TRAY 42
MANOMETERS 8
MASKS – DUST & PARTICLE 44
MEGOHMMETER 2
 AC/DC DIGITAL MULTIMETER WITH
 AUTO SELECTION 2
ANEMOMETER 6
ANALOG METER 3
ANALOG CLAMP ON 3
AUTO-RANGING MULTI-METER 2
DIGITAL CLAMP ON METERS 4
DIGITAL MULTI-METER 3

M (CONTINUED)

METERS CON'T.
 ENVIRONMENTAL KIT 8
 MANOMETER 8
 OPEN JAW VOLTAGE METER 9
 PEN PROBE STYLE 10
 SOUND METER 8
 SUPERHEAT KIT 14
 MICROWAVE LEAK DETECTOR 10
 MIRRORS
 GLASS – TELESCOPIC 11
 REPLACEMENT GLASS 11
 MIRRORS WITH LED LIGHTS 11
 STAINLESS STEEL – TELESCOPIC 11
 MOISTURE INDICATOR 10
 MOUNTING BRACKETS 65
 MOTOR AND PHASE INDICATOR 9
 MULTI-BIT & DRIVER KIT 42
 MULTI-TOOL – MINI POCKET 40

N
 NATURAL GAS INDICATOR 10
 NEOPRENE TUBING 17
 NIPPLES – BLACK WELDED 27
 NIPPLE TRAY 27
 NOZZLE – GARDEN HOSE 68
 NUT DRIVER SET 39
 NUT KITS 54
 NUTS 62
 NYLON INSERT LOCK NUT KIT 54
 NYLON CARRYING POUCH 43

O

OIL PUMP 44
 OIL REFRACTOMETER 61
 OUTLET BOXES 74
 OUTLET BOX COVERS 74

P

PERFORATED STRAP
 GALVANIZED AND COPPER 18
 PEN PROBE STYLE MULTI-METER 10
 PHASE ROTATION INDICATOR 9
 PICK-UP TOOLS 37
 PIPE CLAMPS 18
 PIPE FITTINGS – BLACK IRON 27
 PIPE HANGERS 18
 PIPE JOINT COMPOUND 64
 PIPE NIPPLES 27
 PIPE WRENCHES 37
 PIPING THERMOMETER 15
 PLASTIC HANGER STRAP 18
 PLASTIC SPRAYERS 68
 PLIERS 39
 PRESSURE SWITCHES (HIGH & LOW) 45
 PROPANE GAS INDICATOR 10
 PROTECTIVE COVER
 DUPLEX RECEPTACLE 70
 PSYCHROMETER 8
 PUMP STANDS 21
 PUTTY KNIFE 38
 PVC CEMENT 63
 PVC PIPE CUTTER 41

R

R-410 ADAPTER 26
 REAMER 35
 RECEPTACLES – STRAIGHT BLADE 72
 REFRACTOMETERS – GLYCOL & OIL 61
 REFRIGERANT LABELS 60
 REFRIGERANT RECOVERY CYLINDERS 60
 REFRIGERANT RECOVERY TOOL 39
 REFRIGERANT
 RETENTION CONTROL VALVE 26

R (CONTINUED)

RELAY OVERLOAD 56
 ROPE – POLYPROPYLENE 68
 RUBBER STRAPS 68
 RUBBER VIBRATION PADS 42

S
 SAND CLOTH & PADS 59
 SCALES 61
 SCREWDRIVER BITS 42
 SCREWDRIVER SET 36
 SCREWDRIVERS 36
 SCREWS 42
 SCREWSTARTERS 41
 SCRIBE 37
 SENSORS AC, LOW VOLTAGE AC 56
 SHOE COVERS 44
 SHOP TOWELS 68
 SILICONE TUBING 63
 SMOKE CARTRIDGES 44
 SNIPS 41
 SOCKET SET 38
 SOLENOID VOLTAGE TESTER 56
 SPRAYERS – PLASTIC 68
 STORAGE DRAWERS 43
 STRAINERS – PLASTIC 62
 STRAPS
 NYLON 68
 PERFORATED 18
 RUBBER 68
 STUD SENSOR 10
 SUPER HEAT INSTRUMENT 14
 SWAGING TOOL 35

T

TACHOMETER 9
 TANKS 60
 TAPE 64
 TAPE MEASURE 41
 TERMINALS
 90 DEG. DISCONNECT WITH SCREW 50
 BUTT CONNECTORS 50
 COMPRESSOR 52
 DISCONNECT NON-INSULATED 52
 FLAG DISCONNECT 52
 HIGH TEMPERATURE 52
 QUICK DISCONNECT INSULATED 51
 RING INSULATED 51
 SPADES INSULATED 51
 SPECIAL DEVICES 50
 RING NON-INSULATED 51
 SPADE NON-INSULATED 51
 TERMINAL BLOCKS 55
 TEST LEADS
 ADAPTORS 56
 LOW VOLTAGE 56
 THERMOMETERS
 DIGITAL HAND HELD 15
 DIGITAL STEM 15
 DUAL PROBE 15
 INDOOR/OUTDOOR 16
 INFRAREDS 12
 HORIZONTAL 16
 PIPING 15
 POCKET DIAL 15
 POCKET DIGITAL 15
 POCKET HYGROMETERS 15
 POCKET STICK 15
 ROTARY PROBE 14
 REFRIGERATOR/FREEZER/OVEN 16
 SOLAR POWER 16
 SOLAR POWER REMOTE READING 16
 VAPOR TENSION REMOTE READING 16

T (CONTINUED)

THERMOSTAT COVERS 67
 THERMOSTAT DEFROST 45
 THREADED ROD 62
 TIME DELAYS 21
 TOGGLE SWITCHES 71
 TOOL BAGS 43
 TOOL CASES 43
 TOOLS 35
 TOWELS 68
 TRANSFORMERS 45
 TROUBLE LIGHTS 34
 TUBING 17

U

UV FLASHLIGHTS 33
 UNIT COOLERS 69
 UTILITY BOXES 74
 UTILITY CUTTERS 40

V

V-BELTS 66
 VACUUM CHARGE VALVE & CORE TOOL 26
 VIBRATION ELIMINATORS 46
 VIBRATION PADS 42
 VIDEO BORESCOPE 7
 VOLTAGE TESTER 55

W

WALL PLATES 72
 WASHERS 62
 WASHING MACHINE PANS 61
 WATER HEATER PANS 61
 WATER LINE TAP VALVES 26
 WATTMETER 9
 WHIPS 21
 WIRE
 THHN 58
 GLASS BRAIDED SILICONE RUBBER 58
 POLYETHYLENE RANGE 58
 MOTOR HOOK UP 58
 WIRE CONNECTORS 57
 WIRE MARKER ID SYSTEM DISPENSER 55
 WIRE PIPE HANGERS 18
 WIRE STRIPPERS 39
 WIRE TIE GUN 48
 WIRE TIES 47
 WORKLIGHTS 32
 WRENCHES
 ADJUSTABLE 37
 FLARE NUT 37
 FLEXIBLE RATCHET WRENCH SET 37
 OFFSET 37
 PIPE 37
 REVERSIBLE RATCHET WRENCH SET 37
 STRAIGHT 37

PART #	PG #	PART #	PG #	PART #	PG #	PART #	PG #	PART #	PG #	PART #	PG #
32745	45	3P30A120V	73	8910DPA73V14	73	AMA-007	75	AMA-410	76	AMA-763	76
32750	45	3P30A240V	73	8910DPA93V02	73	AMA-007-2	75	AMA-438	76	AMA-765	76
32755	45	3P30A24V	73	8910DPA93V09	73	AMA-010	77	AMA-481	77	AMA-816	77
32760	45	3P40A120V	73	8910DPA93V14	73	AMA-015	77	AMA-502	75	AMA-824	75
32770	45	3P40A240V	73	AF1000	25	AMA-017	77	AMA-503	77	AMA-825	75
32780	45	3P40A24V	73	AF1000-50	25	AMA-018	77	AMA-504	75	AMA-826	75
32790	45	3P50A120V	73	AF1100	25	AMA-020	77	AMA-505	77	AMA-827	75
33329	45	3P50A240V	73	AF1100-50	25	AMA-026	77	AMA-507	75	AMA-828	75
33330	45	3P50A24V	73	AF11516	25	AMA-044	75	AMA-510	75	AMA-829	75
33353	45	3P60A120V	73	AF1200	25	AMA-130	75	AMA-513	75	AMA-830	75
33354	45	3P60A240V	73	AF1200-50	25	AMA-132	75	AMA-516	75	AMA-831	75
33355	45	3P60A24V	73	AF12516	25	AMA-133	75	AMA-519	75	AMA-832	75
33356	45	4040FS	46	AF1300	25	AMA-1438	76	AMA-522	75	AMA-833	75
33357	45	5050FS	46	AF1300-50	25	AMA-1448	76	AMA-525	75	AMA-834	75
33358	45	5252FS	46	AF13516	25	AMA-200	76	AMA-528	75	AMA-835	75
33359	45	5454FY	46	AF1400	25	AMA-206	76	AMA-530	76	AMA-836	75
33362	45	5614FZ	46	AF1400-50	25	AMA-208	76	AMA-531	75	AMA-924	75
33363	45	6060FS	46	AF1500	25	AMA-210	76	AMA-533	75	AMA-925	75
33364	45	6464FS	46	AF1500-50	25	AMA-212	76	AMA-539	76	AMA-926	75
1010FY	46	7272FS	46	AF1600	25	AMA-214	76	AMA-548	76	AMA-927	75
112P30A120V	73	8080FS	46	AF1600-50	25	AMA-216	76	AMA-565	76	AMA-928	75
112P30A240V	73	8910DP22V02	73	AF1700	26	AMA-218	76	AMA-582	76	AMA-929	75
112P30A24V	73	8910DP22V09	73	AF1700-50	26	AMA-220	76	AMA-602	75	AMA-930	75
1212FY	46	8910DP22V14	73	AF1800	26	AMA-222	76	AMA-604	75	AMA-931	75
1258FY	46	8910DP32V02	73	AF1800-50	26	AMA-224	76	AMA-607	75	AMA-932	75
1418FZ	46	8910DP32V09	73	AF1900	25	AMA-226	76	AMA-610	75	AMA-933	75
181SP-02	17	8910DP32V14	73	AF1900-50	25	AMA-228	76	AMA-613	75	AMA-934	75
181SP-03	17	8910DP42V02	73	AF2000	25	AMA-232	76	AMA-616	75	AMA-935	75
181SP-04	17	8910DP42V09	73	AF2000BX	25	AMA-234	76	AMA-619	75	AMA-936	75
181SP-06	17	8910DP42V14	73	AF2100	25	AMA-236	76	AMA-622	75	AMA-960	75
1A	44	8910DPA23V02	73	AF2100-100	25	AMA-254	77	AMA-625	75	AMA-963	75
1P30A24V	73	8910DPA23V09	73	AF2100-25	25	AMA-306	76	AMA-628	75	AMA-964	75
1P40A24V	73	8910DPA23V14	73	AF2200-M	25	AMA-308	76	AMA-631	75	AMA-965	75
2020FS	46	8910DPA33V02	73	AF3134	26	AMA-312	76	AMA-633	75	AMA-966	75
2B	44	8910DPA33V09	73	AF3135	26	AMA-314	76	AMA-702	75	AMA-967	75
2P20A24V	73	8910DPA33V14	73	AF3136	26	AMA-316	76	AMA-704	75	AMA-968	75
2P30A120V	73	8910DPA43V02	73	AF3138	26	AMA-318	76	AMA-707	75	AMA-969	75
2P30A240V	73	8910DPA43V09	73	AF3140	26	AMA-322	76	AMA-710	75	AMA-970	75
2P30A24V	73	8910DPA43V14	73	AF3142	26	AMA-324	76	AMA-713	75	D109	24
2P40A120V	73	8910DPA53V02	73	AF3144	26	AMA-326	76	AMA-716	75	D110	24
2P40A240V	73	8910DPA53V09	73	AF3148	26	AMA-328	76	AMA-719	75	D111	24
2P40A24V	73	8910DPA53V14	73	AMA-001	75	AMA-332	76	AMA-722	75	D112	24
3030FS	46	8910DPA63V02	73	AMA-001-10	75	AMA-334	76	AMA-725	75	D113	24
3434FY	46	8910DPA63V09	73	AMA-002	75	AMA-336	76	AMA-728	75	D114	24
3458FY	46	8910DPA63V14	73	AMA-002-10	75	AMA-348	76	AMA-731	75	D115	24
3838FZ	46	8910DPA73V02	73	AMA-003	75	AMA-405	77	AMA-733	75	DCH032S	24
3C	44	8910DPA73V09	73	AMA-003-5	75	AMA-406	76	AMA-762	75	DCH033S	24

PART #	PG #	PART #	PG #	PART #	PG #	PART #	PG #	PART #	PG #	PART #	PG #
DCH052F	24	MA-004CR	45	MA01130-2	52	MA02514P	58	MA02707-2	52	MA02872-1	52
DCH052S	24	MA-004RR	45	MA01164-1	57	MA02521-1	49	MA02724-2	52	MA02873-2	52
DCH053S	24	MA-006CR	45	MA01164C-2	57	MA02522-1	49	MA02726-1	52	MA02875-1	52
DCH082S	24	MA-006RR	45	MA01165-1	57	MA02525-2	62	MA02727-2	52	MA02876-2	52
DCH083S	24	MA01012G	58	MA01165C-2	57	MA02525-3	62	MA02729-1	52	MA02881-1	52
DCH163S	24	MA01012P	58	MA01166-1	57	MA02525-EUKIT	62	MA02729-2	52	MA02882-2	52
DCH164S	24	MA01014G	58	MA01166C-2	57	MA02526-1	51	MA02744-1	52	MA02894-1	52
DCH165S	24	MA01014P	58	MA0126-12	41	MA02528-1	51	MA02745-2	52	MA02894-2	52
DCH303S	24	MA01018-1	57	MA0127-16	41	MA02530-1	51	MA02746-1	52	MA02896-1	50
DCH304S	24	MA01018-2	57	MA0128-25	41	MA02532-1	51	MA02747-2	52	MA02896-2	50
DCH305S	24	MA01018-3	57	MA0129-30	41	MA02534-1	51	MA02749-1	52	MA02898-2	50
DCH306S	24	MA01018BX	57	MA-012CR	45	MA02536-1	51	MA02762-2	52	MA02903-1	50
DCH307S	24	MA01019-1	57	MA-012RR	45	MA02537-1	51	MA02770-1	52	MA02904-2	50
DCH309S	24	MA01019-2	57	MA0130-50	41	MA02541-1	51	MA02771-2	52	MA02906-1	50
DCHBF083S	24	MA01019-3	57	MA0131-100	41	MA02543-1	51	MA02773-1	52	MA02907-2	50
DCHBF163S	24	MA01019BX	57	MA-0160T	27	MA02544-1	51	MA02774-2	52	MA02911-2	50
HOM115	73	MA01019P	57	MA-018CR	45	MA02547-1	51	MA02776-1	52	MA02933-1	56
HOM120	73	MA01020-1	57	MA-018RR	45	MA02548-1	50	MA02777-2	52	MA02936-1	56
HOM130	73	MA01020-2	57	MA02012-1	53	MA02549-1	50	MA02779-1	52	MA02939-2	51
HOM140	73	MA01020-3	57	MA02013-1	51	MA02551-1	50	MA02780-2	52	MA02940-2	51
HOM150	73	MA01020BX	57	MA02014-1	50	MA02577-1	51	MA02782-1	52	MA02942-2	51
HOM215	73	MA01020P	57	MA02015-1	53	MA02578-1	51	MA02783-2	52	MA02944-2	51
HOM220	73	MA01021-1	57	MA02043-1	48	MA02579-1	51	MA02785-1	52	MA02951-2	51
HOM230	73	MA01021-2	57	MA02044-1	48	MA02580-1	51	MA02786-2	52	MA02952-2	51
HOM240	73	MA01021-3	57	MA02045-1	48	MA02581-1	51	MA02816-1	50	MA02955-1	51
HOM250	73	MA01021BX	57	MA02046-1	48	MA02583-1	51	MA02818-1	50	MA02955-2	51
HOM260	73	MA01021P	57	MA02065-1	51	MA02584-1	51	MA02820-1	50	MA02956-1	51
MA00014-1	20	MA01022-1	57	MA02065-2	51	MA02585-1	51	MA02821-1	52	MA02960-1	51
MA00030-1	20	MA01022-2	57	MA02066-1	51	MA02586-1	51	MA02822-2	52	MA02962-2	51
MA00036-1	49	MA01022-3	57	MA02066-2	51	MA02587-1	51	MA02823-1	52	MA02968-1	51
MA00098-1	49	MA01022BX	57	MA02109-1	50	MA02588-1	51	MA02824-2	52	MA02968-2	51
MA00099-1	49	MA01022P	57	MA021120-2	48	MA02589-1	51	MA02825-1	52	MA02969-1	51
MA00100-1	49	MA01023-1	50	MA021120-2B	48	MA02590-1	51	MA02826-2	52	MA02969-2	51
MA00101-1	49	MA01023-2	50	MA02127-1	52	MA02591-1	50	MA02827-1	52	MA02971-2	51
MA00102-1	49	MA01029-1	50	MA02127-2	52	MA02592-1	52	MA02828-2	52	MA02973-1	51
MA00151-1	49	MA01029-2	50	MA02142-1	52	MA02595-1	50	MA02830-1	52	MA02974-2	51
MA00152-1	49	MA01042-1	51	MA02142-2	52	MA02596-2	50	MA02833-1	52	MA02975-2	51
MA00153-1	49	MA01042-2	51	MA02148-2	53	MA02597-2	51	MA02834-2	52	MA02977-2	51
MA00154-1	49	MA01043-1	51	MA02149-2	53	MA02598-2	51	MA02837-2	52	MA02978-2	51
MA-002CR	45	MA01043-2	51	MA02150-2	53	MA02618-2	52	MA02839-1	52	MA02980-1	51
MA-002RR	45	MA01046-1	51	MA02151-2	53	MA02619-2	51	MA02840-2	52	MA02982-2	51
MA-00304	45	MA01046-2	51	MA02152-2	53	MA02620-2	51	MA02842-1	52	MA02983-2	51
MA-003CR	45	MA01066-1	50	MA02153-2	53	MA02621-2	51	MA02843-2	52	MA02984-2	56
MA-003RR	45	MA-010669	8	MA-0230	68	MA02622-2	51	MA02860-1	52	MA02984-3	56
MA00478-1	53	MA01123-1	52	MA02512G	58	MA02623-2	51	MA02861-2	52	MA02985-2	56
MA00479-1	53	MA01124-1	52	MA02512P	58	MA02652-2	53	MA02869-1	52	MA02985-3	56
MA00480-1	53	MA01130-1	52	MA02514G	58	MA02653-2	53	MA02870-2	52	MA02987-2	56

PART #	PG #	PART #	PG #	PART #	PG #	PART #	PG #	PART #	PG #	PART #	PG #
MA02991-3	56	MA03161-2	49	MA03221-2	58	MA03355-2	43	MA03540-24	42	MA03773-1	52
MA03011-2	50	MA03162-1	49	MA03221-3	58	MA03360-1	52	MA03541-2	42	MA03774-1	52
MA03012-2	50	MA03162-2	49	MA03222-2	58	MA03361-2	52	MA03541-24	42	MA03775-1	50
MA03013-2	51	MA03163-1	49	MA03222-3	58	MA03362-1	52	MA03542-2	42	MA03775-2	50
MA03015-1	51	MA03163-2	49	MA03223-2	58	MA03363-2	52	MA03543-2	42	MA03776-1	52
MA03016-2	51	MA03164-1	49	MA03223-3	58	MA03364-2	64	MA03544-2	42	MA03778-2	52
MA03018-1	51	MA03164-2	49	MA03224-2	58	MA03373-2	57	MA03545-2	42	MA03779-2	52
MA03019-2	51	MA03165-1	49	MA03224-3	58	MA03375-2	43	MA03546-2	42	MA03780-2	52
MA03022-2	51	MA03165-2	49	MA03225-2	58	MA03376-2	43	MA03565-2	42	MA03781-2	52
MA03023-2	51	MA03166-1	49	MA03225-3	58	MA03383-1	53	MA03565-3	42	MA03782-2	52
MA03028-1	51	MA03166-2	49	MA03226-2	58	MA03385-1	53	MA03566-2	42	MA03783-2	52
MA03029-2	51	MA03167-1	49	MA03226-3	58	MA03387-1	53	MA03566-4	42	MA03784-1	52
MA03033-2	50	MA03167-2	49	MA03227-2	58	MA03389-1	53	MA03567-2	42	MA03784-2	52
MA03034-2	50	MA03168-1	49	MA03227-3	58	MA03391-1	53	MA03567-3	42	MA03785-1	52
MA03035-2	50	MA03168-2	49	MA03228-2	58	MA03393-1	53	MA-0360	68	MA03785-2	52
MA03042-1	50	MA03169-1	49	MA03228-3	58	MA03394-1	53	MA-0361	68	MA03790-2	50
MA03063-1	50	MA03169-2	49	MA03229-2	58	MA03395-1	51	MA036175-2	48	MA03791-2	50
MA03075-1	57	MA03171-1	48	MA03229-3	58	MA03395-2	51	MA036175-2B	48	MA03792-2	50
MA03076-2	57	MA03172-2	48	MA03230-2	58	MA03414-2	42	MA-0362	68	MA03793-1	52
MA03077-1	57	MA03174-1	48	MA03230-3	58	MA03414-4	42	MA-0363	68	MA03793-2	52
MA03090-1	56	MA03175-2	48	MA03231-2	58	MA03415-2	42	MA03750-2	54	MA03794-2	52
MA03092-1	56	MA03177-1	48	MA03231-3	58	MA03415-4	42	MA03751-2	57	MA03798-1	52
MA03093-1	56	MA03178-2	48	MA03232-2	58	MA03416-2	42	MA03752-2	54	MA03798-2	52
MA03096-2	56	MA03180-1	48	MA03232-3	58	MA03416-4	42	MA03754-2	54	MA03802-2	54
MA03149-1	49	MA03181-2	48	MA03233-2	58	MA03417-2	42	MA03756-2	54	MA04132-1	57
MA03149-2	49	MA03183-1	48	MA03233-3	58	MA03417-4	42	MA03757-2	54	MA04233-2	57
MA03150-1	49	MA03184-2	48	MA03234-2	58	MA03465-1	51	MA03758-1	42	MA04501-2	71
MA03150-2	49	MA03185-1	48	MA03234-3	58	MA03466-1	51	MA03758-2	42	MA04502-2	71
MA03151-1	49	MA03188-2	48	MA03235-2	58	MA03467-1	51	MA03758-3	42	MA04503-2	71
MA03151-2	49	MA03189-1	48	MA03235-3	58	MA03467-2	51	MA03759-1	42	MA04504-2	71
MA03152-1	49	MA03190-2	48	MA03236-2	58	MA03469-1	51	MA03759-2	42	MA04505-2	71
MA03152-2	49	MA03192-1	48	MA03236-3	58	MA03469-2	51	MA03759-3	42	MA04506-2	71
MA03153-1	49	MA03193-2	48	MA03237-2	58	MA03471-1	51	MA03760-1	42	MA-04625	59
MA03153-2	49	MA03195-1	48	MA03237-3	58	MA03471-2	51	MA03760-2	42	MA04702-2B	48
MA03154-1	49	MA03196-2	48	MA03238-2	58	MA03473-1	51	MA03760-3	42	MA04704-2B	48
MA03154-2	49	MA03198-1	48	MA03238-3	58	MA03473-2	51	MA03761-1	42	MA04706-2B	48
MA03155-1	49	MA03199-2	48	MA03239-2	58	MA03475-1	51	MA03761-2	42	MA04708-2B	48
MA03155-2	49	MA03200-2	39	MA03239-3	58	MA03475-2	51	MA03761-3	42	MA04710-2B	48
MA03156-1	49	MA03203-2	39	MA03240-2	58	MA03477-1	51	MA03762-1	42	MA04712-2B	48
MA03156-2	49	MA03217-2	58	MA03240-3	58	MA03477-2	51	MA03762-2	42	MA04793-2B	48
MA03157-1	49	MA03217-3	58	MA03241-2	58	MA03500-2	37	MA03762-3	42	MA04796-2B	48
MA03157-2	49	MA03218-2	58	MA03241-3	58	MA-03532	34	MA03763-1	42	MA04799-2B	48
MA03158-1	49	MA03218-3	58	MA03343-1	52	MA-03533	34	MA03763-2	42	MA048175-2	48
MA03158-2	49	MA03219-2	58	MA03344-2	52	MA03539-2	42	MA03763-3	42	MA048175-2B	48
MA03159-1	49	MA03219-3	58	MA03344-3	52	MA03539-24	42	MA03765-1	48	MA05007-2	48
MA03159-2	49	MA03220-2	58	MA03349-1	50	MA0353940-MX	42	MA03771-1	52	MA05008-2	48
MA03161-1	49	MA03220-3	58	MA03353-2	43	MA03540-2	42	MA03772-1	52	MA05012G	58

PART #	PG #	PART #	PG #	PART #	PG #	PART #	PG #	PART #	PG #	PART #	PG #
MA05012P	58	MA-10010	22	MA-1131	68	MA-12053-25	30	MA-12827	2	MA-157A	11
MA05014G	58	MA-1001S	16	MA-11315	44	MA-12053-50	30	MA-12829	3	MA-159A	37
MA05014P	58	MA-10050	22	MA-11354	44	MA-12054	30	MA-12830A	9	MA-15SA	19
MA-05028	44	MA-10075	22	MA-114	37	MA-12054-100	30	MA-12830A-S	9	MA-16501	12
MA05031-2	56	MA-101	63	MA-1141	68	MA-12054-25	30	MA-12835B	8	MA-16505A	12
MA0512G	58	MA-102	63	MA-11830	63	MA-12054-50	30	MA-12837	3	MA-16506	12
MA0512P	58	MA-10214	44	MA-11840	63	MA-12055	30	MA-12838A	8	MA-16507	12
MA0514G	58	MA-10218	44	MA-11853	63	MA-12056	30	MA-12842A	9	MA-16509B	12
MA0514P	58	MA-1028	2	MA-11866	63	MA-12057	30	MA-12843B	8	MA-16531C	8
MA06295-2	57	MA-10344	59	MA-11879	63	MA-12060	31	MA-12844	9	MA-16532	14
MA06295P	57	MA-10345	59	MA-1200	35	MA-12060-100	31	MA-12845A	10	MA-16533	8
MA09353-2	42	MA-10346	59	MA-12004	31	MA-12060-25	31	MA-128500	60	MA-16650	13
MA09354-2	42	MA-10347	59	MA-12004-100	31	MA-12060-50	31	MA-1290EL	27	MA-16551	13
MA-09709	34	MA-10348	59	MA-12004-25	31	MA-1212	71	MA-1290STEL	27	MA-1660A	16
MA-09857	34	MA-10349	59	MA-12004-50	31	MA-1225	71	MA-12CAP	27	MA-1665C	16
MA-09858	34	MA-10350	59	MA-1201	35	MA-12353	6	MA-12CPLG	27	MA-16C81	13
MA0HT12B1	58	MA-1056-075	31	MA-12010	31	MA-12355B	6	MA-12PLG	27	MA-16N	67
MA0HT12B2	58	MA-1056-100	31	MA-12010-100	31	MA-12356	6	MA-12T	27	MA-16RR	67
MA0HT12B3	58	MA-1056-22	31	MA-12010-25	31	MA-12357A	6	MA-12U	27	MA-16SA	19
MA0HT12B4	58	MA-1056-32	31	MA-12010-50	31	MA-12358	6	MA-13025	43	MA-171	41
MA0HT12B5	58	MA-1056-33	31	MA-12013	31	MA-12361	4	MA-132A	41	MA-17255	59
MA0HT12R1	58	MA-1056-44	31	MA-12013-100	31	MA-12362	4	MA-134BG	27	MA-17256	59
MA0HT12R2	58	MA-105NYFIT	29	MA-12013-25	31	MA-1238BG	27	MA-134CPLG	27	MA-17257	59
MA0HT12R3	58	MA10602-1	57	MA-12013-50	31	MA-1245EL	27	MA-14012	63	MA-174	41
MA0HT12R4	58	MA10602-2	57	MA-1202	35	MA-12535	64	MA-14025	63	MA-174D	41
MA0HT12R5	58	MA10602BX	57	MA-12032	30	MA-12537	64	MA-14050	63	MA-175D	41
MA0HT12W1	58	MA10604-1	57	MA-12032-100	30	MA-12545	64	MA-14051	63	MA-176E	41
MA0HT12W2	58	MA10604-2	57	MA-12032-25	30	MA-12547	64	MA-14052	63	MA-179ED	72
MA0HT12W3	58	MA10604BX	57	MA-12032-50	30	MA-12548	64	MA-14053	63	MA-181834	45
MA0HT12W4	58	MA10606-1	57	MA-12033	30	MA-1257	71	MA-14054	63	MA-185	37
MA0HT12W5	58	MA10606-2	57	MA-12033-100	30	MA-1258	71	MA-14055	63	MA-186	37
MA0HT14B1	58	MA10606BX	57	MA-12033-25	30	MA-1266T	27	MA-14056	63	MA-18975	26
MA0HT14B2	58	MA10608-1	57	MA-12033-50	30	MA-12700A	2	MA-14057	63	MA-18985	26
MA0HT14B3	58	MA10608-2	57	MA-12034	30	MA-12701	9	MA-142-1	11	MA-190EL	27
MA0HT14B4	58	MA10608BX	57	MA-12034-100	30	MA-12702	9	MA-142A	11	MA-190STEL	27
MA0HT14B5	58	MA10610P	57	MA-12034-25	30	MA-12813	5	MA-142MA	11	MA-19173	26
MA0HT14R1	58	MA-10DT12	18	MA-12034-50	30	MA-12814	4	MA-143A	11	MA-1CAP	27
MA0HT14R2	58	MA-10DT34	18	MA-12035	30	MA-12815A	9	MA-143M	11	MA-1CPLG	27
MA0HT14R3	58	MA-1109	68	MA-12035-100	30	MA-12815A-24	9	MA-145EL	27	MA-1PLG	27
MA0HT14R4	58	MA-11-12X	63	MA-12035-25	30	MA-12816A	4	MA-147B	36	MA-1RR	39
MA0HT14R5	58	MA-1115	68	MA-12035-50	30	MA-12817B	2	MA-149	11	MA-1T	27
MA0HT14W1	58	MA-1119	68	MA-12052	30	MA-12818	2	MA-149-1	11	MA-1U	27
MA0HT14W2	58	MA-1122	68	MA-12052-100	30	MA-12819	9	MA-1500	62	MA-2001	33
MA0HT14W3	58	MA-112BG	27	MA-12052-25	30	MA-12821	9	MA-15005	22	MA-20010	22
MA0HT14W4	58	MA-112CPLG	27	MA-12052-50	30	MA-12822B	5	MA-15007	22	MA-2001S	16
MA0HT14W5	58	MA-1-12X	63	MA-12053	30	MA-12823	4	MA-15008	22	MA-2002S	16
MA-1001	33	MA-11302	44	MA-12053-100	30	MA-12826B	5	MA-157-1	11	MA-2003S	16

PART #	PG #	PART #	PG #	PART #	PG #	PART #	PG #	PART #	PG #	PART #	PG #
MA-20050	22	MA-22014-100	31	MA-22120	30	MA-22185-50	31	MA-30075	22	MA-31231	64
MA-20075	22	MA-22014-25	31	MA-22120-100	30	MA-22186	31	MA-30105	28	MA-31318	28
MA-202	40	MA-22014-50	31	MA-22120-25	30	MA-22186-100	31	MA-30107	28	MA-31348	28
MA-202RB	40	MA-22031	30	MA-22120-50	30	MA-22186-25	31	MA-30110	28	MA-31405	28
MA-20534	77	MA-22031-100	30	MA-22122	30	MA-22186-50	31	MA-30132	44	MA-31407	28
MA-207013	28	MA-22031-25	30	MA-22122-100	30	MA-22187	31	MA-30155	28	MA-31410	28
MA-207030	28	MA-22031-50	30	MA-22122-25	30	MA-22187-100	31	MA-30157	28	MA-317G	39
MA-20SA	19	MA-22048	31	MA-22122-50	30	MA-22187-25	31	MA-30158	28	MA-322-2	64
MA-21/2SA	19	MA-22048-100	31	MA-22151	30	MA-22187-50	31	MA-301C	40	MA-322-3	64
MA-213	20	MA-22048-25	31	MA-22151-100	30	MA-22192	30	MA-30200	44	MA-3268C	5
MA-22002	31	MA-22048-50	31	MA-22151-25	30	MA-22192-100	30	MA-30275	28	MA-3268WC	5
MA-22002-100	31	MA-22049	31	MA-22151-50	30	MA-22192-25	30	MA-303	43	MA-32831	56
MA-22002-25	31	MA-22049-100	31	MA-22152	30	MA-22192-50	30	MA-303/357RB	33	MA-32832	56
MA-22002-50	31	MA-22049-25	31	MA-22152-100	30	MA-22263	30	MA-30301	20	MA-32905	28
MA-22003	31	MA-22049-50	31	MA-22152-25	30	MA-22263-100	30	MA-30303	20	MA-32907	28
MA-22003-100	31	MA-22064	30	MA-22152-50	30	MA-22263-25	30	MA-30305	28	MA-32950	61
MA-22003-25	31	MA-22064-100	30	MA-22153	30	MA-22263-50	30	MA-30307	28	MA-32N	67
MA-22003-50	31	MA-22064-25	30	MA-22153-100	30	MA-22264	30	MA-30311	28	MA-32SA	19
MA-22005	31	MA-22064-50	30	MA-22153-25	30	MA-22264-100	30	MA-30357	28	MA-33002	26
MA-22005-100	31	MA-22065	30	MA-22153-50	30	MA-22264-25	30	MA-30405	28	MA-33005	26
MA-22005-25	31	MA-22065-100	30	MA-22154	30	MA-22264-50	30	MA-30407	28	MA-33008	26
MA-22005-50	31	MA-22065-25	30	MA-22154-100	30	MA-22286	29	MA-30410	28	MA-33350	68
MA-22006	31	MA-22065-50	30	MA-22154-25	30	MA-22286-100	29	MA-30457	28	MA-33570	68
MA-22006-100	31	MA-22066	30	MA-22154-50	30	MA-22286-25	29	MA-30605	28	MA-337	39
MA-22006-25	31	MA-22066-100	30	MA-22157	29	MA-22286-50	29	MA-30607	28	MA-33905	28
MA-22006-50	31	MA-22066-25	30	MA-22157-100	29	MA-22289	29	MA-30610	28	MA-33907	28
MA-22007	31	MA-22066-50	30	MA-22157-25	29	MA-22289-100	29	MA-30705	28	MA-33910	28
MA-22007-100	31	MA-22112	30	MA-22157-50	29	MA-22289-25	29	MA-30707	28	MA-33C	3
MA-22007-25	31	MA-22112-100	30	MA-22159	29	MA-22289-50	29	MA-30710	28	MA-340-5	60
MA-22007-50	31	MA-22112-25	30	MA-22159-100	29	MA-22290	29	MA-30818	63	MA-341212T	27
MA-22009	31	MA-22112-50	30	MA-22159-25	29	MA-22290-100	29	MA-30821	63	MA-3412BG	27
MA-22009-100	31	MA-22113	30	MA-22159-50	29	MA-22290-25	29	MA-30834	63	MA-3412CPLG	27
MA-22009-25	31	MA-22113-100	30	MA-22160	29	MA-22290-50	29	MA-30847	63	MA-343412T	27
MA-22009-50	31	MA-22113-25	30	MA-22160-100	29	MA-2300	62	MA-30F3	21	MA-3445EL	27
MA-22010	31	MA-22113-50	30	MA-22160-25	29	MA-25E29821	23	MA-30SA	19	MA-3466T	27
MA-22010-100	31	MA-22114	30	MA-22160-50	29	MA-25E29831	23	MA-31012	63	MA-34790	68
MA-22010-25	31	MA-22114-100	30	MA-22161	29	MA-25E29832	23	MA-31013	63	MA-3490EL	27
MA-22010-50	31	MA-22114-25	30	MA-22161-100	29	MA-25E59	23	MA-31014	63	MA-3490STEL	27
MA-22012	31	MA-22114-50	30	MA-22161-25	29	MA-25E80	23	MA-31015	63	MA-34CAP	27
MA-22012-100	31	MA-22116	30	MA-22161-50	29	MA-263	20	MA-311	43	MA-34CPLG	27
MA-22012-25	31	MA-22116-100	30	MA-22182	31	MA-263-R	20	MA-31132	63	MA-34PLG	27
MA-22012-50	31	MA-22116-25	30	MA-22182-100	31	MA-290	36	MA-31133	63	MA-34RUEL	17
MA-22013	31	MA-22116-50	30	MA-22182-25	31	MA-2E1441	23	MA-31226	64	MA-34T	27
MA-22013-100	31	MA-22117	30	MA-22182-50	31	MA-2E1442	23	MA-31227	64	MA-34U	27
MA-22013-25	31	MA-22117-100	30	MA-22185	31	MA-2WK	67	MA-31228	64	MA-3600	54
MA-22013-50	31	MA-22117-25	30	MA-22185-100	31	MA-30038	22	MA-31229	64	MA-3612	54
MA-22014	31	MA-22117-50	30	MA-22185-25	31	MA-30050	22	MA-31230	64	MA-38RUEL	17

PART #	PG #	PART #	PG #	PART #	PG #	PART #	PG #	PART #	PG #	PART #	PG #
MA-398	64	MA-437131	28	MA-4E122	23	MA4L460	66	MA5L350	66	MA-60610	37
MA-398BL	64	MA-437292	28	MA-4E123	23	MA4L470	66	MA5L360	66	MA-60613	37
MA3L310	66	MA-437339	28	MA-4E124	23	MA4L480	66	MA5L370	66	MA-60613-25	37
MA3L320	66	MA-440G	39	MA-4E21	23	MA4L490	66	MA5L380	66	MA-60616	37
MA3L330	66	MA-447025	28	MA-4E22	23	MA4L500	66	MA5L390	66	MA-60616-25	37
MA3L340	66	MA-447040	28	MA-4E23	23	MA4L510	66	MA5L400	66	MA-60743	34
MA3L350	66	MA-448007	28	MA-4E24	23	MA4L520	66	MA5L410	66	MA-60954	34
MA3L360	66	MA-450007	28	MA-4E421	22	MA4L530	66	MA5L420	66	MA-60A	16
MA3L370	66	MA-457005	28	MA-4E422	22	MA4L540	66	MA5L430	66	MA-60AFF	16
MA3L380	66	MA-457007	28	MA-4E48	22	MA4L550	66	MA5L440	66	MA-60F3	21
MA3L390	66	MA-457010	28	MA-4E5090A	21	MA4L560	66	MA5L450	66	MA-60NF3	21
MA3L400	66	MA-457012	28	MA-4E50A	21	MA4L570	66	MA5L460	66	MA-61/4SA	19
MA3L410	66	MA-457015	28	MA-4E51	22	MA4L580	66	MA5L470	66	MA61000	65
MA3L420	66	MA-457020	28	MA-4E57	22	MA4L590	66	MA5L480	66	MA61056	65
MA3L430	66	MA-465	32	MA-4E58	22	MA4L600	66	MA5L490	66	MA-61623	34
MA3L440	66	MA-46810	77	MA-4E59A	23	MA4L610	66	MA5L500	66	MA-6182	53
MA3L450	66	MA-49051	61	MA-4E75	21	MA4L620	66	MA5L510	66	MA-61834	34
MA3L460	66	MA-49052B	61	MA-4E7590	21	MA4L630	66	MA5L520	66	MA-6183	53
MA3L470	66	MA-49052AUS	61	MA4L170	66	MA4L640	66	MA5L530	66	MA-6184	53
MA3L480	66	MA-49052EPC	61	MA4L180	66	MA4L650	66	MA5L540	66	MA-6185	53
MA-40038	33	MA-49090	59	MA4L190	66	MA4L660	66	MA5L550	66	MA-6186	53
MA-40050	33	MA-49091	59	MA4L200	66	MA4L670	66	MA5L560	66	MA-6187	53
MA-40075	33	MA-49092	59	MA4L210	66	MA4L680	66	MA5L570	66	MA-6188	53
MA-400RC123	60	MA-49116	26	MA4L220	66	MA4L690	66	MA5L580	66	MA-6192	53
MA-400RC30	60	MA-49191	59	MA4L230	66	MA4L700	66	MA5L590	66	MA-6193	53
MA-400RC50	60	MA-49192	59	MA4L240	66	MA4L710	66	MA5L600	66	MA-6194	53
MA-401020	28	MA-49193	59	MA4L250	66	MA4L720	66	MA5L610	66	MA-6195	53
MA-401025	28	MA-492B	31	MA4L260	66	MA-4LC20D	21	MA5L620	66	MA-6196	53
MA-4012W	21	MA-492W	31	MA4L270	66	MA-4LC20E	21	MA5L630	66	MA-6197	53
MA-4034W	21	MA-49310	35	MA4L280	66	MA-4LC43D	21	MA5L640	66	MA-6198	53
MA-406025	28	MA-493114	35	MA4L290	66	MA-4LC43E	21	MA5L650	66	MA-6202BX	18
MA-407074	28	MA-49316	35	MA4L300	66	MA-50ABF	16	MA5L660	66	MA-6203BX	18
MA-409010	28	MA-49317	35	MA4L310	66	MA-5406BX	18	MA5L670	66	MA-62044	34
MA-410005	28	MA-49318	35	MA4L320	66	MA-5408BX	18	MA5L680	66	MA-6204BX	18
MA-410007	28	MA-49320	37	MA4L330	66	MA-5410BX	18	MA5L690	66	MA-6205BX	18
MA-410010	28	MA-49324	37	MA4L340	66	MA-5412BX	18	MA5L700	66	MA-6206BX	18
MA-4101	28	MA-49330	37	MA4L350	66	MA-5416BX	18	MA5L710	66	MA-63223	34
MA-410101	28	MA-49331	37	MA4L360	66	MA-5420BX	18	MA5L720	66	MA-63493	34
MA-41300	68	MA-49332	37	MA4L370	66	MA-5428BX	18	MA-5TCA	43	MA-64N	67
MA-417025	28	MA-49333	37	MA4L380	66	MA-5432BX	18	MA60042	65	MA-65093	34
MA-429025	28	MA-49334	37	MA4L390	66	MA-56188	18	MA60048	65	MA-650B	48
MA-430G	39	MA-49858A	56	MA4L400	66	MA-563211	60	MA60049K	65	MA-650N	48
MA-43482	66	MA-4E104A	22	MA4L410	66	MA-572A	68	MA-600CF	6	MA-651	43
MA-43484	66	MA-4E110	22	MA4L420	66	MA-5DT1	18	MA-6012W	21	MA-67363	34
MA-43486	66	MA-4E1101	22	MA4L430	66	MA-5DT112	18	MA60306K	65	MA68004	65
MA-43488	66	MA-4E1102	22	MA4L440	66	MA-5DT114	18	MA-6034W	21	MA-68150	21
MA-436074	28	MA-4E121	23	MA4L450	66	MA5L340	66	MA-60609	37	MA-70059P	36

PART #	PG #	PART #	PG #	PART #	PG #	PART #	PG #	PART #	PG #	PART #	PG #
MA-70072	37	MA-71802P	41	MA-7605	71	MA-7661	72	MA-9311	39	MA-9637	42
MA-70073	37	MA-71803P	41	MA-7606	71	MA-7662	72	MA-9312	39	MA-9637	42
MA-70074	37	MA-72023	34	MA-7607	71	MA-7663	72	MA-9314	39	MA-9638	42
MA-70091	37	MA-72066	37	MA-7608	71	MA-7664	72	MA-9316	39	MA-9639	42
MA-70093	37	MA-72314	34	MA-7611	71	MA-7665	72	MA-93482	66	MA-9640	42
MA-70094	37	MA-72433	39	MA-76110	68	MA-7667	72	MA-93484	66	MA-9641	42
MA-70095	37	MA-72435	39	MA-7612	72	MA-7668	72	MA-93486	66	MA-9642	42
MA-70097	37	MA-72437	39	MA-7613	72	MA-7669	72	MA-93488	66	MA-9643	42
MA-70098	37	MA-72439	39	MA-7614	72	MA-7670	71	MA-9355	39	MA-9644	42
MA-70099	37	MA-72744	34	MA-7615	72	MA-7671	71	MA-9357	36	MA-9645	42
MA-70100	37	MA-72815	28	MA-7617	72	MA-7672	71	MA-9358 -12	36	MA-9646	42
MA-70115	28	MA-72820	28	MA-7618	72	MA-7673	71	MA-9601	42	MA-9647	42
MA-70116	28	MA-72830	28	MA-7621	71	MA-7674	72	MA-9602	42	MA-9648	42
MA-70120	28	MA-7300	44	MA-7624	71	MA-78TERM	50	MA-9603	42	MA-9649	42
MA-70121	28	MA-73093	34	MA-7625	71	MA80105	65	MA-9604	42	MA-9650	42
MA-70122	28	MA-73101	59	MA-7626	71	MA-8016	68	MA-9605	42	MA-9651	42
MA-70130	28	MA-73102	59	MA-7630	72	MA80293	65	MA-9606	42	MA-9652	42
MA-70132	28	MA-73103	59	MA-7631	72	MA-8032	68	MA-9607	42	MA-9653	42
MA-70133	28	MA-73104	59	MA-7632	72	MA-8201	56	MA-9608	42	MA-9654	42
MA-70-14JR	41	MA-73105	59	MA-7633	72	MA-8202A	56	MA-9609	42	MA-9655	42
MA-70151	28	MA-73106	59	MA-7634	72	MA-8203	56	MA-9610	42	MA-9656	42
MA-70152	28	MA-73107	59	MA-7635	72	MA-8205	56	MA-9611	42	MA-9657	42
MA-70153	28	MA-73108	59	MA-7636	72	MA-8250A	61	MA-9612	42	MA-9658	42
MA-70204	34	MA-73109	59	MA-7637	72	MA-8206	56	MA-9613	42	MA-9659	42
MA-70221	28	MA-73110	59	MA-7638	72	MA-8207	56	MA-9614	42	MA-9660	42
MA-70231	28	MA-73111	59	MA-7639	72	MA-821	6	MA-9615	42	MA-9661	42
MA-70232	28	MA-73112	59	MA-7640	72	MA-823	6	MA-9616	42	MA-9662	42
MA-70250	41	MA-7321	56	MA-7641	72	MA-8400	41	MA-9617	42	MA-9663	42
MA-70251	41	MA-7339	10	MA-7642	72	MA-8408	41	MA-9618	42	MA-9664	42
MA-70252	41	MA-73532	44	MA-7643	72	MA-8410	54	MA-9619	42	MA-9665	42
MA-70253	41	MA-73815	28	MA-7644	72	MA-8411	54	MA-9620	42	MA-992015	44
MA-70254	41	MA-73820	28	MA-7645	72	MA-8412	54	MA-9621	42	MA-AA45E	41
MA-70255	41	MA-73830	28	MA-7646	72	MA-8414	54	MA-9622	42	MA-AA46V	41
MA-70256	41	MA-7409	10	MA-7647	72	MA-8415	54	MA-9623	42	MA-AA47R	41
MA-70257	41	MA-74213	34	MA-7648	71	MA-8646L	44	MA-9624	42	MA-ABC-1	20
MA-70343	34	MA-748325A	34	MA-7649	71	MA-8646M	44	MA-9625	42	MA-ABC-10	20
MA-70474	34	MA-7514	72	MA-7650	71	MA-8646XL	44	MA-9626	42	MA-ABC-12	20
MA-70615	28	MA-7515	72	MA-7651	71	MA-88057	35	MA-9627	42	MA-ABC-15	20
MA-70620	28	MA-7518	71	MA-7652	71	MA-88081	35	MA-9628	42	MA-ABC-2	20
MA-70630	28	MA-7519	20	MA-7653TR	71	MA-88091	35	MA-9629	42	MA-ABC-20	20
MA-71115	28	MA-7525	72	MA-7654	71	MA-90303	59	MA-9630	42	MA-ABC-3	20
MA-71120	28	MA-7599	72	MA-7655	71	MA-90304	59	MA-9631	42	MA-ABC-30	20
MA-71130	28	MA-7600	71	MA-7656	71	MA-90502	59	MA-9632	42	MA-ABC-5	20
MA-71-132R	41	MA-7601	71	MA-7657	71	MA-90503	59	MA-9633	42	MA-ABC-6	20
MA-71354	34	MA-7602	71	MA-7658	71	MA-9306	39	MA-9634	42	MA-ABC-8	20
MA-71493	34	MA-7603	71	MA-7659	72	MA-9308	39	MA-9635	42	MA-ACB36	65
MA-71801P	41	MA-7604	71	MA-7660	72	MA-9310	39	MA-9636	42	MA-ACB42	65

PART #	PG #	PART #	PG #	PART #	PG #	PART #	PG #	PART #	PG #	PART #	PG #
MA-ACB48	65	MA-ATC25	20	MA-BN34412	27	MA-C6435BR	64	MA-CP35-240	61	MA-D115	73
MA-AGC-1	20	MA-ATC3	20	MA-BN345	27	MA-C6435G	64	MA-CSSC21-18	59	MA-D120	73
MA-AGC-1/2	20	MA-ATC30	20	MA-BN34512	27	MA-C6435GN	64	MA-CSSC21-24	59	MA-D120	73
MA-AGC-1/32	20	MA-ATC4	20	MA-BN346	27	MA-C6435O	64	MA-CSSC21-36	59	MA-D130	73
MA-AGC-1/4	20	MA-ATC5	20	MA-BN34CL	27	MA-C6435R	64	MA-CSSC21-48	59	MA-D130040	28
MA-AGC-10	20	MA-ATC7.5	20	MA-BP001	43	MA-C6435W	64	MA-CSSC21-60	59	MA-D140	73
MA-AGC-11/2	20	MA-BC1	18	MA-BP112	27	MA-C6435Y	64	MA-CSSC21-72	59	MA-D150	73
MA-AGC-11/4	20	MA-BC112	18	MA-BP118	27	MA-C6488	64	MA-CSSC54-12	59	MA-D160	73
MA-AGC-15	20	MA-BC114	18	MA-BP1212	27	MA-C950	64	MA-CSSC54-18	59	MA-D215	73
MA-AGC-2	20	MA-BC12	18	MA-BP1218	27	MA-C950-4	64	MA-CSSC54-24	59	MA-D220	73
MA-AGC-20	20	MA-BC14	18	MA-BP1224	27	MA-CCT11	47	MA-CSSC54-36	59	MA-D230	73
MA-AGC-25	20	MA-BC2	18	MA-BP1230	27	MA-CCT11-K	47	MA-CSSC54-48	59	MA-D240	73
MA-AGC-3	20	MA-BC34	18	MA-BP1236	27	MA-CCT14	47	MA-CSSC54-60	59	MA-D250	73
MA-AGC-3/4	20	MA-BC38	18	MA-BP124	27	MA-CCT14-K	47	MA-CSSC54-72	59	MA-D260	73
MA-AGC-30	20	MA-BDHTR	16	MA-BP1248	27	MA-CCT15	47	MA-CSSD54-12	59	MA-D300040	28
MA-AGC-4	20	MA-BDIOT	16	MA-BP1260	27	MA-CCT15-K	47	MA-CSSD54-18	59	MA-D304040	28
MA-AGC-5	20	MA-BF1	63	MA-BP130	27	MA-CCT7	47	MA-CSSD54-24	59	MA-D309015	28
MA-AGC-6	20	MA-BFC	63	MA-BP136	27	MA-CCT7-K	47	MA-CSSD54-36	59	MA-D309020	28
MA-AGC-7	20	MA-BI4	62	MA-BP148	27	MA-CCW403	66	MA-CSSD54-48	59	MA-D309030	28
MA-AGC-8	20	MA-BI6	62	MA-BP160	27	MA-CCW404	66	MA-CSSD54-60	59	MA-D321040	28
MA-AGC-9	20	MA-BN12	27	MA-BP3412	27	MA-CCW505	66	MA-CSSD54-72	59	MA-D323015	28
MA-AL9V	33	MA-BN12112	27	MA-BP3418	27	MA-CCW605	66	MA-CT1	64	MA-D323020	28
MA-ALAA	33	MA-BN1212	27	MA-BP3424	27	MA-CCW606	66	MA-CVT1	17	MA-D323030	28
MA-ALAAA	33	MA-BN122	27	MA-BP3430	27	MA-CCW703	66	MA-CVT12	17	MA-D400040	28
MA-ALC	33	MA-BN12212	27	MA-BP3436	27	MA-CF1	18	MA-CVT14	17	MA-DLSN71	7
MA-ALD	33	MA-BN123	27	MA-BP3448	27	MA-CF-100	18	MA-CVT316	17	MA-DM1	4
MA-AN84A	8	MA-BN12312	27	MA-BP3460	27	MA-CF-50	18	MA-CVT34	17	MA-DMT123	14
MA-AP132	33	MA-BN124	27	MA-BT1	18	MA-CGD383	10	MA-CVT38	17	MA-DMT123KIT	14
MA-AP3172	33	MA-BN12412	27	MA-BT112	18	MA-CGD383-SP	10	MA-CVT58	17	MA-DMT3	4
MA-AP890	40	MA-BN125	27	MA-BT114	18	MA-CH100	61	MA-CVT78	17	MA-DMTK	4
MA-AP8SD	36	MA-BN12512	27	MA-BT12	18	MA-CH101	61	MA-CW300	66	MA-DMTKA	4
MA-AT12	17	MA-BN126	27	MA-BT2	18	MA-CH101-1	61	MA-CW301	66	MA-DMTK1	4
MA-AT14	17	MA-BN12CL	27	MA-BT34	18	MA-CH101-2	61	MA-CW401	66	MA-DMTL	4
MA-AT14-5	17	MA-BN13	27	MA-BTG54VL	67	MA-CH101-3	61	MA-CW406	66	MA-DMTL1	4
MA-AT18	17	MA-BN1312	27	MA-BTG54VLW	67	MA-CH102	61	MA-CW501	66	MA-DMTP	4
MA-AT18-5	17	MA-BN14	27	MA-BTGDB	67	MA-CH102-1	61	MA-CW502	66	MA-DS4	62
MA-AT316	17	MA-BN1412	27	MA-BTGDK	67	MA-CH102-2	61	MA-CW503	66	MA-DS6	62
MA-AT316-5	17	MA-BN15	27	MA-BTGEK	67	MA-CH103	61	MA-CW601	66	MA-DT1	18
MA-AT38	17	MA-BN1512	27	MA-BTGK	67	MA-CH103-2	61	MA-CW650	66	MA-DT112	18
MA-AT38-5	17	MA-BN16	27	MA-BTGKM	67	MA-CH135	61	MA-CW652	66	MA-DT114	18
MA-AT516	17	MA-BN1CL	27	MA-BTGRK	67	MA-CIMK2	62	MA-CW665	66	MA-DT12	18
MA-AT58	17	MA-BN34112	27	MA-BTGUK2	67	MA-CKN1	39	MA-CW701	66	MA-DT2	18
MA-AT716	17	MA-BN342	27	MA-BTGUM	67	MA-CL1	35	MA-CW801	66	MA-DT34	18
MA-ATC10	20	MA-BN34212	27	MA-BTGUWM	67	MA-CO801	9	MA-CW802	66	MA-E0PL	22
MA-ATC15	20	MA-BN343	27	MA-C6408	64	MA-CP1	61	MA-D100040	28	MA-E100	21
MA-ATC2	20	MA-BN34312	27	MA-C6433	64	MA-CP2	61	MA-D102420	28	MA-E10090	21
MA-ATC20	20	MA-BN344	27	MA-C6435B	64	MA-CP35-120	61	MA-D102422	28	MA-E104A	22

PART #	PG #	PART #	PG #	PART #	PG #	PART #	PG #	PART #	PG #	PART #	PG #
MA-E105	22	MA-E298-31	23	MA-E51	22	MA-ECNR35	19	MA-FNM30	20	MA-FRSR12	19
MA-E106	22	MA-E298-32	23	MA-E52PL	23	MA-ECNR40	19	MA-FNM35	20	MA-FRSR125	19
MA-E107	22	MA-E298-41	23	MA-E554	74	MA-ECNR45	19	MA-FNM40	20	MA-FRSR15	19
MA-E10S	23	MA-E298-42	23	MA-E560	74	MA-ECNR5	19	MA-FNQ10	20	MA-FRSR150	19
MA-E110	22	MA-E298-43	23	MA-E564	74	MA-ECNR50	19	MA-FNQ12	20	MA-FRSR175	19
MA-E110-1	22	MA-E298-51	23	MA-E57	22	MA-ECNR6.25	19	MA-FNQ15	20	MA-FRSR2	19
MA-E110-2	22	MA-E298-52	23	MA-E570	74	MA-ECNR60	19	MA-FNQ20	20	MA-FRSR2.5	19
MA-E110-3	22	MA-E298-53	23	MA-E571	74	MA-ECNR70	19	MA-FNQ25	20	MA-FRSR20	19
MA-E110-4	22	MA-E298-54	23	MA-E572	74	MA-ECNR80	19	MA-FNQ30	20	MA-FRSR200	19
MA-E110-5	22	MA-E2PL	22	MA-E573	74	MA-ECSR10	19	MA-FRBS8	38	MA-FRSR225	19
MA-E121	23	MA-E2PL-1	22	MA-E574	74	MA-ECSR100	19	MA-FRNR1	19	MA-FRSR25	19
MA-E122	23	MA-E2PL25	22	MA-E575	74	MA-ECSR125	19	MA-FRNR1.25	19	MA-FRSR3.2	19
MA-E123	23	MA-E30	23	MA-E58	22	MA-ECSR15	19	MA-FRNR1.6	19	MA-FRSR30	19
MA-E124	23	MA-E303	74	MA-E584	74	MA-ECSR150	19	MA-FRNR10	19	MA-FRSR35	19
MA-E125	23	MA-E303D	74	MA-E59	23	MA-ECSR20	19	MA-FRNR100	19	MA-FRSR4	19
MA-E126	23	MA-E304EXT	74	MA-E590	74	MA-ECSR200	19	MA-FRNR110	19	MA-FRSR40	19
MA-E127	23	MA-E350EXT	74	MA-E594	74	MA-ECSR25	19	MA-FRNR12	19	MA-FRSR45	19
MA-E128	23	MA-E352	74	MA-E5S	23	MA-ECSR30	19	MA-FRNR125	19	MA-FRSR5	19
MA-E129	23	MA-E353	74	MA-E60PL	23	MA-ECSR35	19	MA-FRNR15	19	MA-FRSR50	19
MA-E130	23	MA-E353D	74	MA-E61PL	23	MA-ECSR40	19	MA-FRNR150	19	MA-FRSR6.25	19
MA-E144-1	23	MA-E363D	74	MA-E65PL	23	MA-ECSR45	19	MA-FRNR175	19	MA-FRSR60	19
MA-E144-2	23	MA-E37-1	23	MA-E69PL	23	MA-ECSR50	19	MA-FRNR2	19	MA-FRSR70	19
MA-E1PL	22	MA-E37-2	23	MA-E75	21	MA-ECSR60	19	MA-FRNR2.5	19	MA-FRSR8	19
MA-E200	74	MA-E37-3	23	MA-E7590	21	MA-ECSR70	19	MA-FRNR20	19	MA-FRSR80	19
MA-E200EXT	74	MA-E374	74	MA-E7S	23	MA-ECSR80	19	MA-FRNR200	19	MA-FRSR90	19
MA-E201	74	MA-E374D	74	MA-E80	23	MA-ECSR90	19	MA-FRNR225	19	MA-FT1A	64
MA-E201-3/4	74	MA-E376	23	MA-E81	23	MA-EM3213A	10	MA-FRNR25	19	MA-FWP1/2	38
MA-E202	74	MA-E377	23	MA-E82	23	MA-EM3215	10	MA-FRNR3.2	19	MA-FWP1/4	38
MA-E21	23	MA-E378	23	MA-E83	23	MA-ETP110	16	MA-FRNR30	19	MA-FWP10MM	38
MA-E22	23	MA-E379	23	MA-E900	23	MA-EXT4	21	MA-FRNR35	19	MA-FWP11MM	38
MA-E23	23	MA-E380	23	MA-E901	23	MA-F336	67	MA-FRNR4	19	MA-FWP13MM	38
MA-E2390-2	23	MA-E3PL	22	MA-E902	23	MA-FA134	44	MA-FRNR40	19	MA-FWP14MM	38
MA-E24	23	MA-E3PL-1	22	MA-E903	23	MA-FB2	35	MA-FRNR45	19	MA-FWP16MM	38
MA-E25	23	MA-E3PL25	22	MA-E904	23	MA-FL1063C	32	MA-FRNR5	19	MA-FWP3/8	38
MA-E251	74	MA-E42-1	22	MA-E96-1CG	23	MA-FL1438	32	MA-FRNR50	19	MA-FWP5/16	38
MA-E252	74	MA-E42-2	22	MA-E96-2CG	23	MA-FL3A	33	MA-FRNR6.25	19	MA-FWP5/8	38
MA-E253	74	MA-E42-3	22	MA-E96-4CG	23	MA-FL3BUV	33	MA-FRNR60	19	MA-FWP6MM	38
MA-E254	74	MA-E42-4	22	MA-E96-5CG	23	MA-FL460	32	MA-FRNR70	19	MA-FWP7	38
MA-E255	74	MA-E42-5	22	MA-ECNR10	19	MA-FL6287	32	MA-FRNR8	19	MA-FWP7-MET	38
MA-E26	23	MA-E48	22	MA-ECNR100	19	MA-FM50	65	MA-FRNR80	19	MA-FWP7/16	38
MA-E27	23	MA-E4PL	22	MA-ECNR125	19	MA-FM55	65	MA-FRNR90	19	MA-FWP8MM	38
MA-E272	74	MA-E504	74	MA-ECNR15	19	MA-FM554A	65	MA-FRSR1	19	MA-FWP9/16	38
MA-E273	74	MA-E508D	74	MA-ECNR20	19	MA-FNM10	20	MA-FRSR1.25	19	MA-GF1	18
MA-E274	74	MA-E508T	74	MA-ECNR200	19	MA-FNM12	20	MA-FRSR1.6	19	MA-GF-100	18
MA-E28	23	MA-E509	74	MA-ECNR25	19	MA-FNM15	20	MA-FRSR10	19	MA-GF-50	18
MA-E29	23	MA-E5090A	21	MA-ECNR3.2	19	MA-FNM20	20	MA-FRSR100	19	MA-GH25	68
MA-E298-21	23	MA-E50A	21	MA-ECNR30	19	MA-FNM25	20	MA-FRSR110	19	MA-GH50	68

PART #	PG #	PART #	PG #	PART #	PG #	PART #	PG #	PART #	PG #	PART #	PG #
		MA-KVS008A	40	MA-MDL-3/4	20	MA-NON45	19	MA-P6012W	21	MA-PVC42	41
		MA-L42	41	MA-MDL-30	20	MA-NON50	19	MA-P6034W	21	MA-PWN46	57
MA-HDT1	17	MA-L42RB	41	MA-MDL-4	20	MA-NON6	19	MA-PAK-1	48	MA-Q115	73
MA-HDT12	17	MA-L50	41	MA-MDL-5	20	MA-NON60	19	MA-PAK-2	48	MA-Q120	73
MA-HDT14	17	MA-L50RB	41	MA-MDL-6	20	MA-NON70	19	MA-PAK-3	48	MA-Q125	73
MA-HDT316	17	MA-LC20D	21	MA-MDL-7	20	MA-NON80	19	MA-PDT392B	15	MA-Q130	73
MA-HDT34	17	MA-LC20E	21	MA-MDL-8	20	MA-NS1	35	MA-PG1	66	MA-Q140	73
MA-HDT38	17	MA-LC43D	21	MA-MFC1	35	MA-NS1000	35	MA-PH100	18	MA-Q150	73
MA-HDT58	17	MA-LC43E	21	MA-MFC2	35	MA-NS12	35	MA-PH50	18	MA-Q160	73
MA-HDT78	17	MA-LF462C	34	MA-MFC3	35	MA-NS14	35	MA-PLB1	33	MA-Q2100	73
MA-HML3C	32	MALS-105A	69	MA-MGT1	42	MA-NS16	35	MAPLPH1050A	70	MA-Q2125	73
MA-HP3	21	MALS-105A-P	69	MA-MHG-2	7	MA-NS18	35	MAPLPH1210E	70	MA-Q215	73
MA-HP3-2P	21	MALS-125E1	69	MAMJ120	70	MA-NS2	35	MAPLPH1810E	70	MA-Q220	73
MA-HP6	21	MALS-135A	69	MAMJ120-P	70	MA-NS2000	35	MAPLPH2010E	70	MA-Q225	73
MA-HP6-2P	21	MALS-135A-P	69	MAMJ40	70	MA-NS22	35	MAPLPH2410E	70	MA-Q230	73
MA-HRFT1	16	MALS-160E1	69	MAMJ40-P	70	MA-NS24	35	MAPLPH2610A	70	MA-Q240	73
MA-HS50	61	MALS-190A	69	MAMJ70	70	MA-NS26	35	MAPLPH360E	70	MA-Q250	73
MA-HT1	63	MALS-190A-P	69	MAMJ70-P	70	MA-NS28	35	MAPLPH410	70	MA-Q260	73
MA-HT64	63	MALS-210E1	69	MAMJ90	70	MA-NS32	35	MAPLPH530A	70	MA-Q270	73
MA-HTSS-R	63	MALS-210E2	69	MAMJ90-P	70	MA-NS36	35	MAPLPH660A	70	MA-Q280	73
MA-HU1	62	MALS-240A	69	MA-MMD3E	10	MA-NS40	35	MAPLPH660E	70	MA-Q290	73
MA-HWA02	18	MALS-280E1	69	MA-MT13	40	MA-NSPD1	35	MAPLPH710A	70	MA-QP400	39
MA-HWA05	18	MALS-280E2	69	MA-MT53	40	MA-NW110	18	MAPLPH910E	70	MA-QP400-12	39
MA-HWG02	18	MALS-320A	69	MA-MT62	40	MA-NW1126	18	MA-PLT11	47	MA-QP400-G	39
MA-HWG05	18	MALS-410A	69	MA-MY69	3	MA-NW1126-C	18	MA-PLT11-K	47	MA-QT1515	73
MA-IC13	56	MALS-50E1	69	MA-N12	62	MA-NW1128	18	MA-PLT14	47	MA-QT1520	73
MA-IC15	56	MALS-55A	69	MA-N14	62	MA-NW1128-C	18	MA-PLT14-K	47	MA-QT2020	73
MA-IM24A	11	MALS-55A-P	69	MA-N38	62	MA-NW11410	18	MA-PLT4	47	MA-QT2030	73
MA-IM30A	11	MALS-95E1	69	MA-N516	62	MA-NW1146	18	MA-PLT4-K	47	MA-QT3030	73
MA-IMK1	62	MA-MAG1	36	MA-NAT18-5	17	MA-NW1146-C	18	MA-PLT7	47	MA-R134ASC	60
MA-IR9PEN	13	MA-MC123	43	MA-NAT316	17	MA-NW1148	18	MA-PLT7-K	47	MA-R402ASC	60
MA-J1500	18	MA-MC22C	22	MA-NAT316-5	17	MA-NW1148-C	18	MA-PS120	15	MA-R407CSC	60
MA-J2000	18	MA-MC23C	22	MA-ND14516	39	MA-NW1210	18	MA-PS220	15	MA-RECTSC	60
MA-J3000	18	MA-MC42C	22	MA-NDK16	38	MA-NW124	18	MA-PT110C	15	MA-REF401C	61
MA-J4000	18	MA-MC43C	22	MA-NON1	19	MA-NW124-C	18	MA-PT134160	15	MA-REF401F	61
MA-K1	18	MA-MDL-1	20	MA-NON10	19	MA-NW126	18	MA-PT134220	15	MA-REF700	61
MA-K112	18	MA-MDL-1/2	20	MA-NON100	19	MA-NW126-C	18	MA-PT138160	15	MA-RPW20	34
MA-K114	18	MA-MDL-1/4	20	MA-NON15	19	MA-NW16	18	MA-PT138220	15	MA-RRWBK	38
MA-K12	18	MA-MDL-10	20	MA-NON150	19	MA-NW16-C	18	MA-PT14	17	MA-RS121	36
MA-K2	18	MA-MDL-11/4	20	MA-NON175	19	MA-NW344	18	MA-PT160	15	MA-RS300	68
MA-K212	18	MA-MDL-15	20	MA-NON20	19	MA-NW344-C	18	MA-PT160B	15	MA-RT1	16
MA-K3	18	MA-MDL-2	20	MA-NON200	19	MA-NW346	18	MA-PT220	15	MA-RT330	14
MA-K34	18	MA-MDL-20	20	MA-NON25	19	MA-NW346-C	18	MA-PT220B	15	MA-RT335	14
MA-KC710	40	MA-MDL2-1/2	20	MA-NON3	19	MA-OCPI	44	MA-PT38	17	MA-RT340	14
MA-KN15	40	MA-MDL-25	20	MA-NON30	19	MA-OVN1	16	MA-PT550	15	MA-RT340LS	14
MA-KN74HD	40	MA-MDL-3	20	MA-NON35	19	MA-P4012W	21	MA-PT70C	15	MA-RT343	14
MA-KVS007A	40	MA-MDL-3.2	20	MA-NON40	19	MA-P4034W	21	MA-PVC27	41	MA-RT8100	16

PART #	PG #	PART #	PG #	PART #	PG #	PART #	PG #	PART #	PG #	PART #	PG #
MA-RT8101	16	MA-SDF1SC	60	MA-SR134A-50	60	MA-SUT45	16	MA-THHNS-12R	58	MA-TX482	45
MA-RT819	15	MASF-105	69	MA-SR22	60	MA-SVOM18	26	MA-THHNS-12W	58	MA-TX501	45
MA-RT900A	14	MASF-105-P	69	MA-SR22-50	60	MA-SW70C-6	68	MA-THHNS-14B	58	MA-TX502	45
MA-S1A	19	MASF-135	69	MA-SR402A-50	60	MA-T1005	27	MA-THHNS-14G	58	MA-TX775	45
MA-S10A	19	MASF-135-P	69	MA-SR402B	60	MA-T1007	27	MA-THHNS-14R	58	MA-TX779	45
MA-S11/4A	19	MASF-175	69	MA-SR402B-50	60	MA-T1010	27	MA-THHNS-14W	58	MA-UO65P010	21
MA-S12A	19	MASF-175-P	69	MA-SR404A	60	MA-T1057	27	MA-TL15A	19	MA-V1	26
MA-S14	62	MASF-235	69	MA-SR404A-50	60	MA-T10A	19	MA-TL20A	19	MA-V2	26
MA-S144	68	MASF-235-P	69	MA-SR406A	60	MA-T11/4A	19	MA-TL25A	19	MA-VID-1	7
MA-S15A	19	MASF-305	69	MA-SR406A-50	60	MA-T12A	19	MA-TL30A	19	MA-VID-2	7
MA-S16A	19	MASF-305-P	69	MA-SR407C	60	MA-T15A	19	MATM-100	70	MA-VIMK2	62
MA-S20A	19	MA-SH1500	18	MA-SR407C-50	60	MA-T16A	19	MATM-100-P	70	MA-VIMK3	62
MA-S21/2A	19	MA-SH2000	18	MA-SR408A	60	MA-T1A	19	MATM-135	70	MA-VTC1	35
MA-S25	41	MA-SH3000	18	MA-SR408A-50	60	MA-T20A	19	MATM-135-P	70	MA-W10A	19
MA-S25A	19	MA-SH4000	18	MA-SR409A	60	MA-T21/2A	19	MATM-180	70	MA-W12	62
MA-S25RB	41	MA-SHCFC123	60	MA-SR409A-50	60	MA-T25A	19	MATM-180-P	70	MA-W14	62
MA-S2A	19	MA-SHCFC123-50	60	MA-SR410A	60	MA-T2A	19	MATM-250	70	MA-W38	62
MA-S30	68	MA-SL15A	19	MA-SR410A-50	60	MA-T30A	19	MATM-250-P	70	MA-W3A	19
MA-S3003	10	MA-SL20A	19	MA-SR417A	60	MA-T32A	19	MA-TN5044	29	MA-W455	68
MA-S31A	19	MA-SL25A	19	MA-SR417A-50	60	MA-T4A	19	MA-TN5044-100	29	MA-W516	62
MA-S32A	19	MA-SL30A	19	MA-SR421A	60	MA-T5A	19	MA-TN5044-25	29	MA-W5A	19
MA-S38	62	MA-SM6	11	MA-SR421A-50	60	MA-T61/4A	19	MA-TN5044-50	29	MA-W6A	19
MA-S4A	19	MA-SM7	11	MA-SR422B	60	MA-T7A	19	MA-TN5066	29	MA-W8A	19
MA-S5A	19	MA-SM8	11	MA-SR422B-50	60	MA-T8A	19	MA-TN5066-100	29	MA-WHP22	61
MA-S60	68	MA-SMO1	60	MA-SR422D	60	MA-TBS31	36	MA-TN5066-25	29	MA-WHP24	61
MA-S61/4A	19	MA-SMO1-50	60	MA-SR422D-50	60	MA-THHN10B	58	MA-TN5066-50	29	MA-WHP26	61
MA-S6A	19	MA-SNAT316-5	17	MA-SR438A	60	MA-THHN10G	58	MA-TN5088	29	MA-WHP28	61
MA-S8A	19	MA-SND80	8	MA-SR438A-50	60	MA-THHN10R	58	MA-TN5088-100	29	MA-WHP32	61
MA-SAB1	60	MA-SOC19	38	MA-SR500	60	MA-THHN10W	58	MA-TN5088-25	29	MA-WL10C	34
MA-SAB1-50	60	MA-SOC19-MET	38	MA-SR500-50	60	MA-THHN12B	58	MA-TN5088-50	29	MA-WP1	61
MA-SB35	65	MA-SP41501	68	MA-SR502	60	MA-THHN12G	58	MA-TN51212	29	MA-WR6	37
MA-SC10	20	MA-SP44	68	MA-SR502-50	60	MA-THHN12R	58	MA-TN51212-100	29	MA-WR8	37
MA-SC1200CF	44	MA-SP45	68	MA-SR507	60	MA-THHN12W	58	MA-TN51212-25	29	MA-WR10	37
MA-SC15	20	MA-SP46	68	MA-SR507-50	60	MA-THHN14B	58	MA-TN51212-50	29	MA-WR12	37
MA-SC150CF	44	MA-SPA1	60	MA-SRT14-5	17	MA-THHN14G	58	MA-TR12	62	MA-WR681012	37
MA-SC20	20	MA-SPA1-50	60	MA-SRT18-5	17	MA-THHN14R	58	MA-TR14	62	MA-WSFD30A	21
MA-SC25	20	MA-SPO1	60	MA-SRT316-5	17	MA-THHN14W	58	MA-TR38	62	MA-WSFD60A	21
MA-SC30	20	MA-SPO1-50	60	MA-SRU	20	MA-THHN8B	58	MA-TR516	62	MA-WSNFD60A	21
MA-SC35	20	MA-SR11	60	MA-SRY	20	MA-THHN8G	58	MA-TX100	45	MA-WTJ1	48
MA-SC40	20	MA-SR11-50	60	MA-SSC-CK	63	MA-THHN8R	58	MA-TX202	45	MA-XL80-25	68
MA-SC45	20	MA-SR113	60	MA-SSG-CK	63	MA-THHN8W	58	MA-TX205	45	MA-XL80-5	68
MA-SC50	20	MA-SR113-50	60	MA-SSU	20	MA-THHNS-10B	58	MA-TX402	45	MA-XP5	21
MA-SC5000CF	44	MA-SR114	60	MA-SSW	20	MA-THHNS-10G	58	MA-TX403	45	MA-XP6	21
MA-SC60	20	MA-SR114-50	60	MA-SSW-CK	63	MA-THHNS-10R	58	MA-TX404	45	MA-XP8	21
MA-SC600CF	44	MA-SR12	60	MA-SSX	20	MA-THHNS-10W	58	MA-TX405	45		
MA-SDB2	36	MA-SR12-50	60	MA-SSY	20	MA-THHNS-12B	58	MA-TX406	45		
MA-SDB8	36	MA-SR134A	60	MA-ST200	15	MA-THHNS-12G	58	MA-TX407	45		

PHONE: 1-800-956-8220
PHONE: 1-847-956-8200

MA-LINE 2018 CATALOG
www.ma-line.com

FAX: 1-800-336-8291
FAX: 1-847-956-8237

PART #	PG #	PART #	PG #	PART #	PG #	PART #	PG #	PART #	PG #	PART #	PG #
QO115	62	QO230	62	T 0210	49	T 085	49	VE318OD	39		
QO120	62	QO240	62	T 0220	49	VE118OD	39	VE34OD	39		
QO130	62	QO250	62	T 0230	49	VE12OD	39	VE358OD	39		
QO140	62	QO260	62	T 0240	49	VE138OD	39	VE38OD	39		
QO150	62	T 002	49	T 027	49	VE14OD	39	VE418OD	39		
QO160	62	T 003	49	T 032	49	VE158OD	39	VE58OD	39		
QO215	62	T 018	49	T 076	49	VE218OD	39	VE78OD	39		
QO220	62	T 019	49	T 080	49	VE258OD	39				

WARRANTY - All products sold are warranted by MA-Line Division/Monti & Associates Inc. (Hereinafter MA-Line/Monti) only to Purchaser for resale or for use in business or original equipment manufacture, against defects in workmanship or materials under normal use for one year after date of purchase, except where the manufacturer's guarantee is for a shorter period, or unless otherwise stated. MA-Line/Monti's only obligation and Purchaser's only remedy is to refund the purchase price. All other warranties express or implied, including but not limited to the implied warranties of merchantability and fitness for a particular purpose are specifically disclaimed. No warranty or affirmation of fact, express or implied, other than as set forth herein is made or authorized by MA-Line/Monti. MA-Line/Monti shall not be responsible for consequential, incidental, special, exemplary, or punitive damages. MA-Line/Monti's liability in all circumstances shall not exceed the purchase price paid for the product that give rise to any liability. **MA-Line/Monti disclaims any liability for product claims that are due to product misuse, improper product selection, or misapplication.** **Any product description does not express or imply a warranty that the products are merchantable or fit for a particular purpose.** Illustrations and descriptions in this catalog are for the sole purpose of identification, and do not express or imply a warranty that the products are merchantable for a particular purpose, or that the products will conform to the illustrations or descriptions. MA-Line/Monti cannot be held responsible for typographical or photographic errors. MA-Line/Monti reserves the right to change the design, or materials of its products without notification. **MA-Line/Monti specifically disclaims any warranty to cover replacement labor costs, or any cost claim incidental to the defective product, replacement, or reinstallation, or field repair expenses.** Different localities, states and nations have different codes and regulations governing sales, construction, installation, and or use of products for certain purposes. While the MA-Line/Monti attempts to assure that its products are in compliance with such codes, it cannot be responsible for how the product is installed or used. Before purchasing the product, it is the purchaser's responsibility to review the product application, and national and local code regulations, and be certain that the product, installation, and use of the product will comply with them.

WARNING: ALL MA-LINE PRODUCTS ARE FOR LICENSED AND PROFESSIONAL TRADESPEOPLE ONLY.

USE EXTREME CARE WHEN CHECKING ELECTRICAL CIRCUITS TO AVOID ELECTRICAL SHOCK. DO NOT APPLY MORE THAN THE RATED VOLTAGE AS MARKED ON THE PRODUCT. USE PROPER PROTECTIVE EQUIPMENT AS REQUIRED. ANYONE USING THIS PRODUCT SHOULD BE KNOWLEDGEABLE AND TRAINED ABOUT THE RISKS INVOLVED WITH MEASURING ELECTRICAL CIRCUITS. OUR METERS ARE DESIGNED FOR TRADE PROFESSIONALS WHO ARE FAMILIAR WITH THE REQUIRED SAFETY PROCEDURES AND THE HAZARDS OF THEIR TRADE.



CUSTOMER SERVICE E-MAIL:

kjohnson@ma-line.com
bcarlstrand@ma-line.com
bsullivan@ma-line.com

TOLL FREE CUSTOMER SERVICE:

PHONE: 1-800-956-8220
 FAX: 1-800-336-8291

INT'L CUSTOMER SERVICE:

PHONE: 001(847) 956-8200
 FAX: 001(847) 956-8237